

Roland®

RG-7

Roland Digital Grand

OWNER'S MANUAL

Roland®

RG-7

Roland Digital Grand



OWNER'S MANUAL

Before using this unit, carefully read the sections entitled: "IMPORTANT SAFETY INSTRUCTIONS" (p. 2), "USING THE UNIT SAFELY" (p. 3), and "IMPORTANT NOTES" (p. 6). These sections provide important information concerning the proper operation of the unit. Additionally, in order to feel assured that you have gained a good grasp of every feature provided by your new unit, owner's manual should be read in its entirety. The manual should be saved and kept on hand as a convenient reference.

Copyright © 2005 ROLAND CORPORATION

All rights reserved. No part of this publication may be reproduced in any form without the written permission of ROLAND CORPORATION.

WARNING: To reduce the risk of fire or electric shock, do not expose this apparatus to rain or moisture.

  
ATTENTION: RISQUE DE CHOC ELECTRIQUE NE PAS OUVRIR
CAUTION: TO REDUCE THE RISK OF ELECTRIC SHOCK, DO NOT REMOVE COVER (OR BACK). NO USER-SERVICEABLE PARTS INSIDE. REFER SERVICING TO QUALIFIED SERVICE PERSONNEL.



The lightning flash with arrowhead symbol, within an equilateral triangle, is intended to alert the user to the presence of uninsulated "dangerous voltage" within the product's enclosure that may be of sufficient magnitude to constitute a risk of electric shock to persons.



The exclamation point within an equilateral triangle is intended to alert the user to the presence of important operating and maintenance (servicing) instructions in the literature accompanying the product.

INSTRUCTIONS PERTAINING TO A RISK OF FIRE, ELECTRIC SHOCK, OR INJURY TO PERSONS.

IMPORTANT SAFETY INSTRUCTIONS SAVE THESE INSTRUCTIONS

WARNING - When using electric products, basic precautions should always be followed, including the following:

1. Read these instructions.
2. Keep these instructions.
3. Heed all warnings.
4. Follow all instructions.
5. Do not use this apparatus near water.
6. Clean only with a dry cloth.
7. Do not block any of the ventilation openings. Install in accordance with the manufacturers instructions.
8. Do not install near any heat sources such as radiators, heat registers, stoves, or other apparatus (including amplifiers) that produce heat.
9. Do not defeat the safety purpose of the polarized or grounding-type plug. A polarized plug has two blades with one wider than the other. A grounding type plug has two blades and a third grounding prong. The wide blade or the third prong are provided for your safety. If the provided plug does not fit into your outlet, consult an electrician for replacement of the obsolete outlet.
10. Protect the power cord from being walked on or pinched particularly at plugs, convenience receptacles, and the point where they exit from the apparatus.
11. Only use attachments/accessories specified by the manufacturer.
12. Unplug this apparatus during lightning storms or when unused for long periods of time.
13. Refer all servicing to qualified service personnel. Servicing is required when the apparatus has been damaged in any way, such as power-supply cord or plug is damaged, liquid has been spilled or objects have fallen into the apparatus, the apparatus has been exposed to rain or moisture, does not operate normally, or has been dropped.

For the U.K.

WARNING: THIS APPARATUS MUST BE EARTHED

IMPORTANT: THE WIRES IN THIS MAINS LEAD ARE COLOURED IN ACCORDANCE WITH THE FOLLOWING CODE.
GREEN-AND-YELLOW: EARTH, BLUE: NEUTRAL, BROWN: LIVE

As the colours of the wires in the mains lead of this apparatus may not correspond with the coloured markings identifying the terminals in your plug, proceed as follows:

The wire which is coloured GREEN-AND-YELLOW must be connected to the terminal in the plug which is marked by the letter E or by the safety earth symbol  or coloured GREEN or GREEN-AND-YELLOW.

The wire which is coloured BLUE must be connected to the terminal which is marked with the letter N or coloured BLACK.

The wire which is coloured BROWN must be connected to the terminal which is marked with the letter L or coloured RED.



USING THE UNIT SAFELY

INSTRUCTIONS FOR THE PREVENTION OF FIRE, ELECTRIC SHOCK, OR INJURY TO PERSONS

About ⚠ WARNING and ⚠ CAUTION Notices









⚠ WARNING	Used for instructions intended to alert the user to the risk of death or severe injury should the unit be used improperly.
⚠ CAUTION	Used for instructions intended to alert the user to the risk of injury or material damage should the unit be used improperly. * Material damage refers to damage or other adverse effects caused with respect to the home and all its furnishings, as well to domestic animals or pets.

About the Symbols







	The ⚠ symbol alerts the user to important instructions or warnings. The specific meaning of the symbol is determined by the design contained within the triangle. In the case of the symbol at left, it is used for general cautions, warnings, or alerts to danger.
	The ⚡ symbol alerts the user to items that must never be carried out (are forbidden). The specific thing that must not be done is indicated by the design contained within the circle. In the case of the symbol at left, it means that the unit must never be disassembled.
	The ⚡ symbol alerts the user to things that must be carried out. The specific thing that must be done is indicated by the design contained within the circle. In the case of the symbol at left, it means that the power-cord plug must be unplugged from the outlet.

ALWAYS OBSERVE THE FOLLOWING









⚠ WARNING

- Before using this unit, make sure to read the instructions below, and the Owner's Manual. 
- Connect mains plug of this model to a mains socket outlet with a protective earthing connection. 
- Do not open or perform any internal modifications on the unit. 
- Do not attempt to repair the unit, or replace parts within it (except when this manual provides specific instructions directing you to do so). Refer all servicing to your retailer, the nearest Roland Service Center, or an authorized Roland distributor, as listed on the "Information" page. 
- Never use or store the unit in places that are:
 - Subject to temperature extremes (e.g., direct sunlight in an enclosed vehicle, near a heating duct, on top of heat-generating equipment); or are 
 - Damp (e.g., baths, washrooms, on wet floors); or are 
 - Humid; or are
 - Exposed to rain; or are
 - Dusty; or are
 - Subject to high levels of vibration.
- When installing the piano, be sure to fasten the caster using the supplied caster cup. 
- Make sure you always have the unit placed so it is level and sure to remain stable. Never place it on stands that could wobble, or on inclined surfaces. 
- The unit should be connected to a power supply only of the type described in the operating instructions, or as marked on the bottom of unit. 











⚠ WARNING

- Use only the attached power-supply cord. Also, the supplied power cord must not be used with any other device. 
- Do not excessively twist or bend the power cord, nor place heavy objects on it. Doing so can damage the cord, producing severed elements and short circuits. Damaged cords are fire and shock hazards! 
- This unit, either alone or in combination with an amplifier and headphones or speakers, may be capable of producing sound levels that could cause permanent hearing loss. Do not operate for a long period of time at a high volume level, or at a level that is uncomfortable. If you experience any hearing loss or ringing in the ears, you should immediately stop using the unit, and consult an audiologist. 
- Do not allow any objects (e.g., flammable material, coins, pins); or liquids of any kind (water, soft drinks, etc.) to penetrate the unit. 

- Immediately turn the power off, remove the power cord from the outlet, and request servicing by your retailer, the nearest Roland Service Center, or an authorized Roland distributor, as listed on the "Information" page when:
 - The power-supply cord, or the plug has been damaged; or
 - If smoke or unusual odor occurs
 - Objects have fallen into, or liquid has been spilled onto the unit; or
 - The unit has been exposed to rain (or otherwise has become wet); or
 - The unit does not appear to operate normally or exhibits a marked change in performance.
 - If error messages (Error.60, Error.61, Error.62, Error.63) have appeared.

⚠ WARNING

- In households with small children, an adult should provide supervision until the child is capable of following all the rules essential for the safe operation of the unit. 
- Protect the unit from strong impact. (Do not drop it!) 
- Do not force the unit's power-supply cord to share an outlet with an unreasonable number of other devices. Be especially careful when using extension cords—the total power used by all devices you have connected to the extension cord's outlet must never exceed the power rating (watts/amperes) for the extension cord. Excessive loads can cause the insulation on the cord to heat up and eventually melt through. 
- Before using the unit in a foreign country, consult with your retailer, the nearest Roland Service Center, or an authorized Roland distributor, as listed on the "Information" page. 
- Batteries must never be recharged, heated, taken apart, or thrown into fire or water. 

- DO NOT play a CD-ROM disc on a conventional audio CD player. The resulting sound may be of a level that could cause permanent hearing loss. Damage to speakers or other system components may result. 
- Be careful not to touch the keys while the automatic keyboard is functioning, as this may sprain your fingers or damage the keyboard. 
- Do not put anything that contains water (e.g., flower vases) on this unit. Also, avoid the use of insecticides, perfumes, alcohol, nail polish, spray cans, etc., near the unit. Swiftly wipe away any liquid that spills on the unit using a dry, soft cloth. 

⚠ CAUTION

- The unit should be located so that its location or position does not interfere with its proper ventilation. 
- Always grasp only the plug on the power-supply cord when plugging into, or unplugging from, an outlet or this unit. 
- At regular intervals, you should unplug the power plug and clean it by using a dry cloth to wipe all dust and other accumulations away from its prongs. Also, disconnect the power plug from the power outlet whenever the unit is to remain unused for an extended period of time. Any accumulation of dust between the power plug and the power outlet can result in poor insulation and lead to fire. 
- Try to prevent cords and cables from becoming entangled. Also, all cords and cables should be placed so they are out of the reach of children. 
- If the unit could become a hazard if it moves, all caster wheels should be locked or fixed in place once the unit has been placed at the place of installation, or has been loaded onto a vehicle. 
- Never climb on top of, nor place heavy objects on the unit. 
- Never handle the power cord or its plugs with wet hands when plugging into, or unplugging from, an outlet or this unit. 
- Before moving the unit, disconnect the power plug from the outlet, and pull out all cords from external devices. 
- Before cleaning the unit, turn off the power and unplug the power cord from the outlet (p. 19). 
- Whenever you suspect the possibility of lightning in your area, pull the plug on the power cord out of the outlet. 

⚠ CAUTION

- If used improperly, batteries may explode or leak and cause damage or injury. In the interest of safety, please read and observe the following precautions (p. 32).



- Carefully follow the installation instructions for batteries, and make sure you observe the correct polarity.
- Avoid using new batteries together with used ones. In addition, avoid mixing different types of batteries.
- Remove the batteries whenever the unit is to remain unused for an extended period of time.
- If a battery has leaked, use a soft piece of cloth or paper towel to wipe all remnants of the discharge from the battery compartment. Then install new batteries. To avoid inflammation of the skin, make sure that none of the battery discharge gets onto your hands or skin. Exercise the utmost caution so that none of the discharge gets near your eyes. Immediately rinse the affected area with running water if any of the discharge has entered the eyes.
- Never keep batteries together with metallic objects such as ballpoint pens, necklaces, hairpins, etc.

-
- Used batteries must be disposed of in compliance with whatever regulations for their safe disposal that may be observed in the region in which you live.



-
- Be careful when opening/closing the lid so you do not get your fingers pinched (p. 18). Adult supervision is recommended whenever small children use the unit.



-
- Always keep the following parts including with the RG-7 and small components that may be removed out of the reach of small children to avoid accidental ingestion of these parts.



Included Parts

- Piano leg washers
- Bolts, washers, and springs used in attaching the pedals
- Cord clamps used for securing pedal cords, other cord clamps (using double-sided tape), and cord clamp attachment screws
- Pedal stay securing screws

Removable parts

- USB memory anti-theft lock (metal side), Anti-theft lock securing screw
-

IMPORTANT NOTES

In addition to the items listed under “IMPORTANT SAFETY INSTRUCTIONS” and “USING THE UNIT SAFELY” on pages 2, 3, 4 and 5, please read and observe the following:

Power Supply

- Do not connect this unit to same electrical outlet that is being used by an electrical appliance that is controlled by an inverter (such as a refrigerator, washing machine, microwave oven, or air conditioner), or that contains a motor. Depending on the way in which the electrical appliance is used, power supply noise may cause this unit to malfunction or may produce audible noise. If it is not practical to use a separate electrical outlet, connect a power supply noise filter between this unit and the electrical outlet.
- Batteries are supplied with the unit. The life of these batteries may be limited, however, since their primary purpose was to enable testing.
- Before connecting this unit to other devices, turn off the power to all units. This will help prevent malfunctions and/or damage to speakers or other devices.
- Although the LCD and LEDs are switched off when the POWER switch is switched off, this does not mean that the unit has been completely disconnected from the source of power. If you need to turn off the power completely, first turn off the POWER switch, then unplug the power cord from the power outlet. For this reason, the outlet into which you choose to connect the power cord’s plug should be one that is within easy reach and readily accessible.

Placement

- Using the unit near power amplifiers (or other equipment containing large power transformers) may induce hum. To alleviate the problem, change the orientation of this unit; or move it farther away from the source of interference.
- This device may interfere with radio and television reception. Do not use this device in the vicinity of such receivers.
- Noise may be produced if wireless communications devices, such as cell phones, are operated in the vicinity of this unit. Such noise could occur when receiving or initiating a call, or while conversing. Should you experience such problems, you should relocate such wireless devices so they are at a greater distance from this unit, or switch them off.
- Do not expose the unit to direct sunlight, place it near devices that radiate heat, leave it inside an enclosed vehicle, or otherwise subject it to temperature extremes. Also, do not allow lighting devices that normally are used while their light source is very close to the unit (such as a piano light), or powerful spotlights to shine upon the same area of the unit for extended periods of time. Excessive heat can deform or discolor the unit.

- When moved from one location to another where the temperature and/or humidity is very different, water droplets (condensation) may form inside the unit. Damage or malfunction may result if you attempt to use the unit in this condition. Therefore, before using the unit, you must allow it to stand for several hours, until the condensation has completely evaporated.
- Do not allow rubber, vinyl, or similar materials to remain on the unit for long periods of time. Such objects can discolor or otherwise harmfully affect the finish.
- Do not allow objects to remain on top of the keyboard. This can be the cause of malfunction, such as keys ceasing to produce sound.
- Do not paste stickers, decals, or the like to this instrument. Peeling such matter off the instrument may damage the exterior finish.

Maintenance

- Since your piano has a polished finish that is as delicate as that found on finely crafted wooden furniture, it needs careful, periodic care. A few important suggestions concerning the proper care of the unit follow.
 - For dusting, using a soft, clean cloth and/or piano-use feather duster. Be sure to wipe gently. Even the tiniest grains of sand or grit can leave scratches on the surface if too much force is applied while wiping. Do not use any cleaners or detergents, since they might deteriorate the surface of the cabinet, and produce cracks.
 - If the cabinet’s surface loses its luster, wipe it thoroughly with a soft cloth dampened with a little of the polishing liquid. Do not use any cleaners or detergents, since they might deteriorate the surface of the cabinet, and produce cracks. Do not use dusting cloths that contain chemicals.
- Never use benzine, thinners, alcohol or solvents of any kind, to avoid the possibility of discoloration and/or deformation.
- The pedals of this unit are made of brass. Brass eventually darkens as the result of the natural oxidization process. If the brass becomes tarnished, polish it using commercially available metal polisher.

Repairs and Data

- Please be aware that all data contained in the unit’s memory may be lost when the unit is sent for repairs. Important data should always be backed up on a USB memory, or written down on paper (when possible). During repairs, due care is taken to avoid the loss of data. However, in certain cases (such as when circuitry related to memory itself is out of order), we regret that it may not be possible to restore the data, and Roland assumes no liability concerning such loss of data.

Automatic Keyboard

- While the automatic keyboard is in operation, avoid doing anything that could hamper the action of the keys, such as using undue force to press a key, or forcing up a depressed key. By doing so, you risk causing malfunction.

Additional Precautions

- Please be aware that the contents of memory can be irretrievably lost as a result of a malfunction, or the improper operation of the unit. To protect yourself against the risk of losing important data, we recommend that you periodically save a backup copy of important data you have stored in the unit's memory on a USB memory.
- Unfortunately, it may be impossible to restore the contents of data that was stored on a USB memory and internal memory once it has been lost. Roland Corporation assumes no liability concerning such loss of data.
- Use a reasonable amount of care when using the unit's buttons, sliders, or other controls; and when using its jacks and connectors. Rough handling can lead to malfunctions.
- Never strike or apply strong pressure to the display.
- When connecting / disconnecting all cables, grasp the connector itself—never pull on the cable. This way you will avoid causing shorts, or damage to the cable's internal elements.
- A small amount of heat will radiate from the unit during normal operation.
- To avoid disturbing your neighbors, try to keep the unit's volume at reasonable levels. You may prefer to use headphones, so you do not need to be concerned about those around you (especially when it is late at night).
- When you need to transport the unit, pack it in shock-absorbent material. Transporting the unit without doing so can cause it to become scratched or damaged, and could lead to malfunction.
- Do not apply undue force to the music stand while it is in use.
- Use a cable from Roland to make the connection. If using some other make of connection cable, please note the following precautions.
 - Some connection cables contain resistors. Do not use cables that incorporate resistors for connecting to this unit. The use of such cables can cause the sound level to be extremely low, or impossible to hear. For information on cable specifications, contact the manufacturer of the cable.

- Before opening or closing the keyboard lid, always make sure that no pets or other small animals are located on top of the instrument (in particular, they should be kept away from the keyboard and its lid). Otherwise, due to the structural design of this instrument, small pets or other animals could end up getting trapped inside it. If such a situation is encountered, you must immediately switch off the power and disconnect the power cord from the outlet. You should then consult with the retailer from whom the instrument was purchased, or contact the nearest Roland Service Center.

Before Using USB Memory

Using USB Memory

- When connecting USB memory, make sure to press it until it is fully inserted.
- Never touch the terminals of the USB memory. Also, avoid getting the terminals dirty.
- USB memories are constructed using precision components; handle the cards carefully, paying particular note to the following.
 - To prevent damage to the cards from static electricity, be sure to discharge any static electricity from your own body before handling the cards.
 - Do not touch or allow metal to come into contact with the contact portion of the cards.
 - Do not bend, drop, or subject cards to strong shock or vibration.
 - Do not keep cards in direct sunlight, in closed vehicles, or other such locations (storage temperature: 0 to 50° C).
 - Do not allow cards to become wet.
 - Do not disassemble or modify the cards.
- Insert the USB memory in the Ext Memory port evenly and without undue force. Forcing the USB memory may damage the Ext Memory port.
- Do not insert any object other than the USB memory (e.g., wires, coins, other types of disks, etc.) in the Ext Memory port. This may damage the Ext Memory port.
- Do not subject the Ext Memory port cover or connected USB memory to excessive stress.
- Close the USB memory cover when using the USB memory for extended periods

IMPORTANT NOTES



Before Using CDs

Handling the CD Drive

- Avoid using the unit immediately after it has been moved to a location with a level of humidity that is greatly different than its former location. Rapid changes in the environment can cause condensation to form inside the drive, which will adversely affect the operation of the drive and/or damage discs. When the unit has been moved, allow it to become accustomed to the new environment (allow a few hours) before operating it.
- Remove any disc from the drive before powering up or down.
- To avoid the risk of malfunction and/or damage, insert only discs with into the CD drive. Never insert any other type of disc. Avoid getting paper clips, coins, or any other foreign objects inside the drive.
- Do not subject to vibrations or physical shock during use, and do not move the unit while the power is turned on.
- The pickup is of dust-resistant construction. Do not use pickup cleaners or other such materials, as they may damage the pickup.

Handling the CDs

- When handling the discs, please observe the following.
 - Do not touch the recorded surface of the disc.
 - Do not use in dusty areas.
 - Do not leave the disc in direct sunlight or an enclosed vehicle.
- Avoid touching or scratching the shiny underside (encoded surface) of the disc. Damaged or dirty CD-ROM discs may not be read properly. Keep your discs clean using a commercially available CD cleaner.
- Keep the disc in the case.
- Do not keep the disc in the CD drive for a long time.
- Do not put a sticker on the label of the disc.
- Wipe the disc with a soft and dry cloth radially from inside to outside. Do not wipe along circumference.
- Do not use benzine, record cleaner spray or solvents of any kind.
- Do not bend the disc. Bending discs may prevent proper reading and writing of data, and may further result in malfunction.

- * GS () is a registered trademark of Roland Corporation.
- * Mac OS is a trademark of Apple Computer, Inc.
- * XG lite () is a registered trademark of Yamaha Corporation.
- * All product names mentioned in this document are trademarks or registered trademarks of their respective owners.

Introduction

Thank you, and congratulations on your choice of the Roland RG-7 Digital Grand Piano.

The RG-7 is sure to be highly appreciated, not only for the authentic piano performances it offers, but also for its extensive selection of player piano functions.

In order to enjoy reliable performance of your new keyboard for many years to come, please take the time to read through this manual in its entirety.

Main Features

Piano Sounds with Rich Resonance and Wide-Ranging Expressiveness

The stereo sampling piano sound generator realistically reproduces even the sound of the hammers striking the strings, producing the tones of a high-quality concert grand piano.

Maximum polyphony of 128 notes ensures that you can use the pedal freely without running out of notes.

Roland Digital Grand Brings Refinement to Interior Style

The RG-7 exhibits elegance in form with a beautiful black, mirror-like surface. With features just like those found on an acoustic grand, such as a lid that opens and closes and retractable music rest, this instrument is a perfect match for lounge or living room.

The simple, modern, and stylish panel design makes switching tones and making settings a snap.

Full Complement of Player Piano Functions

The RG-7 comes programmed with song data in jazz and classical styles. You can also use the CD drive to play back a wide variety of music on the CD included with the instrument as well as songs on CD-ROMs containing saved SMF files, player piano CDs, and audio CDs. Moreover, you can add song data by copying songs saved on USB memory and CD-ROMs to the RG-7's "Favorites."

The RG-7 includes a "Moving Key" function, which plays the keys along with the song, providing exquisite performances that are played automatically.

Also included is a convenient remote control you can use for selecting songs, adjusting volume, switching the Moving Key function on and off simply and easily. You can connect an external display or television set to the RG-7 for enlarged displays of the Song Select screen, karaoke screen (lyrics screen), notation, and even slide shows.

Instrument Endowed with Superior Basic Functions

The RG-7 uses the progressive hammer action keyboard, which reproduces the touch of a grand piano, with a heavier feel in the lower registers and a lighter, quicker response in the upper registers. This keyboard also accurately reproduces the distinctive clicking feel that occurs when the keys are played gently (escapement mechanism).

The instrument further is equipped with highly responsive pedals, which lend even greater expressive detail to your performances.

The RG-7 also is programmed with 20 carefully selected performance tones, including two types of grand piano tones, which you can select according to your own taste. What's more, the settings for the "key touch," "hammer response," and other precision tone adjustment settings that performers demand can be stored in the RG-7 itself.

On top of this, a newly designed sound system puts the focus on the sound of the piano to achieve a luscious, natural piano sound.

Introduction

Professional-Level Features and Specifications

The instrument features a lid lock to prevent unauthorized operation of the controls or keys while the Moving Key function is in use, and an Ext Memory port lock to prevent theft of connected USB memory.

Since the RG-7 is a digital instrument, it has no strings and therefore requires no tuning.

You can connect an external display or television to the piano to run slide shows using whatever images you prefer and, with a microphone connected, you can add echo and harmonies to microphone vocals and use the Transformer function to change the sound of the vocals.

Connect External Speakers to Produce Concert Hall Presence

You can connect an amp and speakers to the RG-7 and play the sounds of the reverb and accompaniment through the external speakers to produce the effect of being enveloped by an orchestra.

The RG-7 is equipped with XLR connectors, a very convenient feature when the instrument is used on stage.

■ Conventions Used in This Manual

This manual uses the following conventions in the interest of simpler, more concise instructions.

- Button names are enclosed in square brackets “[]”, as in [Moving Key] button.
- An asterisk (*) or a **NOTE** at the beginning of a paragraph indicates a note or precaution. These should not be ignored.
- (p. **) refers to pages within the manual.

Contents

USING THE UNIT SAFELY	3
IMPORTANT NOTES	6
Introduction	9
Main Features	9
Conventions Used in This Manual	10
Panel Descriptions.....	14
Front Panel.....	14
Jack Panel (Left Side of Bottom Panel)	15
CD Drive (Right Side of Bottom Panel).....	16
Before You Start Playing.....	17
Opening and Closing the Top	17
Raising the Music Rest.....	18
Extending the Music Rest	18
Opening and Closing the Lid	18
Using the Lid Lock.....	18
Connect the Pedal Cord.....	19
Connecting the Power Cord.....	19
Turning the Power On and Off	19
Adjusting the Sound's Volume and Brilliance.....	20
About the Pedals.....	20
Connecting Headphones	21
Connecting a Microphone.....	21
Connecting USB Memory.....	22
Connecting the Memory	22
About the Screens.....	23
Main Screens.....	23
Adjusting the Contrast of the Screen.....	23
Chapter 1. Playing Back Songs	24
Look at What You Can Do with the RG-7!	24
Listening to Songs	25
[Song] Button Functions.....	25
Listening to the Tone Demos.....	26
Listening to the Internal Songs.....	26
Listening to Songs on CDs.....	28
Playing Back Songs from USB Memory.....	31
Using the Remote Control.....	32
Installing Batteries in the Remote Control	32
How to Use the Remote Control	33
About the Remote Control.....	34
Using the Aux Input Jack	36
Changing the Song Tempo.....	37
Using the Karaoke Feature.....	37
Changing the Key of the Song Being Played (Playback Transpose).....	38
Adding Echo to the Mic Vocals (Mic Echo).....	39
Adding Harmonies to the Mic Vocals (Harmony).....	40
Altering Vocals (Transformer)	41
Copying Songs	42
Copying Songs Saved on CDs and USB Memory to the "Favorites"	42
Deleting Songs Saved to the "Favorites" or USB Memory.....	45
Chapter 2. Using the RG-7 with an External Display or Television..	47
Connecting an External Display	47
Making the Connections	47
Changing the Display Settings.....	48

Connecting a Television	49
Making the Connections	49
Switching Television Formats	49
Selecting What is To Be Displayed on the External Display or Television.....	50
Displaying Favorite Images on an External Display or Television (Slide Show)	51
Changing the Background for the Lyrics Screen	52
Chapter 3. Performance	53
Performing with a Variety of Sounds.....	53
Changing the Volume Balance of the Layered Tones (Layer Balance)	54
Making Fine Adjustments to the Piano Sound	55
Adjusting the Keyboard Touch (Key Touch).....	55
Changing the Timing of Sounds According to the Force Used to Press the Keys (Hammer Response)	56
Playing Sounds When the Keys Are Released (Key Off Resonance)	57
Producing the Resonance of the Strings When the Keys Are Played (String Resonance) .	58
Producing the Resonance of the Strings When the Keys Are Played (Damper Resonance).....	59
Adjusting the Sound to Achieve the Preferred Tone Quality (Equalizer).....	60
Changing the Pitch of the Keyboard Sound (Transpose)	61
Tuning to Other Instruments' Pitches (Master Tuning)	62
Setting the Tuning Curve (Stretch Tuning)	63
Changing the Tuning	64
Setting the Tonic.....	65
Playing Different Tones with the Left and Right Hands (Split Performance).....	66
Changing the Keyboard's Split Point.....	67
Adding Reverberation to the Sound (Reverb)	68
Assigning Functions to Pedals	69
Changing the Volume Balance of the Accompaniment and the Keyboard.....	71
Remembering the Settings Even When the Power is Turned Off (Memory Backup)	72
Restoring the Factory Settings (Factory Reset).....	73
Chapter 4. Recording the Performance	74
Notes Regarding Recording	74
Recording Performances	74
Play Back the Recorded Performance	75
Saving Recorded Performances.....	76
Deleting Performances Saved to the "Favorites" or USB Memory.....	77
Chapter 5. User Program Registration.....	78
Saving Performance Settings (User Program).....	79
Calling Up Saved User Programs	80
Saving the User Program Sets.....	81
Loading Saved User Program Sets.....	83
Deleting Saved User Program Sets	85
Using the Pedal to Switch User Programs.....	87
Chapter 6. Changing Various Settings	88
Changing the Moving Key Settings	88
Stopping the Keyboard Movement	88
Making Detailed Settings	88
Changing the Part That Makes the Keys Move.....	89
Changing the Remote Control Settings.....	89
Disabling Use of the Remote Control.....	89
Changing the Functions of the Remote Control's Buttons.....	90
Changing the CD Settings.....	91
Adjusting the CD Level.....	91
Synchronizing the Timing of the Piano and Accompaniment	91

Setting the Type of CD To Be Played Back.....	91
Initializing the User Memory or USB Memory	92
Using the V-LINK Function.....	92
Playing the Automatic Demos.....	93
Muting a Specific Part (Minus One Part).....	93
Changing the Notation Display Settings	94
Setting the Part to Which Harmonies Are Added (Harmony Part).....	95
Changing the Infrared Transmission Function Settings.....	96
Switching Infrared Transmissions On and Off (Infrared Function).....	96
Setting Playback After the Song is Transferred (Infrared Playback).....	96
Chapter 7. Connecting External Devices.....	97
Connecting to Audio Equipment.....	97
Connectors	97
Making the Connections	97
Connecting External Speakers.....	98
Changing the Aux Output Jacks Settings.....	98
Setup Examples With Aux Output Set to “Surround”	99
Connecting MIDI Devices.....	99
What’s MIDI?.....	99
Connectors	99
Making the Connections	100
Making MIDI-related Settings.....	100
MIDI Send Channel Settings	100
Disconnecting the Internal Sound Generator and Keyboard (Local Control)	101
Sending Tone Change Messages (Program Change/Bank Select MSB/Bank Select LSB)	101
Sending Recorded Performance Data to a MIDI Device (Composer MIDI Out).....	102
Connecting to the Computer	103
Making the Settings for the USB Driver.....	103
Appendices	
Error Messages.....	106
Tone List	107
Internal Song List.....	108
Parameters Stored to Internal Memory.....	109
Parameters Stored in Memory Backup	109
Parameters Stored in the User Program	109
Music Files That the RG-7 Can Use	110
The RG-7 allows you to use the following music files.....	110
About the RG-7 Sound Generator	110
MIDI Implementation Chart.....	111
Main Specifications	112
Index.....	114

Panel Descriptions

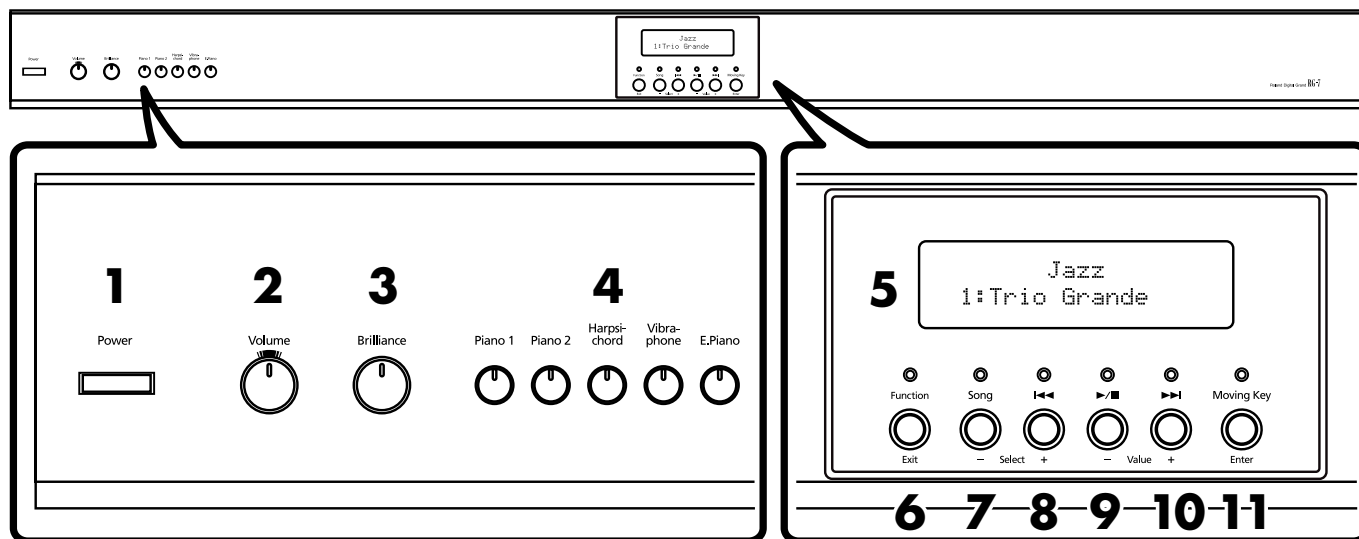

Front Panel

- 1. [Power] switch**
Turns the power on/off (p. 19).
- 2. [Volume] knob**
Adjusts the overall volume level (p. 20).
- 3. [Brilliance] knob**
Adjusts the tone brightness (p. 20).
- 4. Tone Buttons**
They are used to choose the kinds of tones (tone groups) played by the keyboard (p. 53).
[Piano 1] button
[Piano 2] button
[Harpsichord] button
[Vibraphone] button
[E.Piano] button
- 5. Display**
Tone and song names and the values of various settings are displayed here (p. 23).
- 6. [Function] (Exit) button**
This switches the RG-7 to the Function screen (p. 88). You can make various different settings in the Function screen, including settings for the master tuning and temperaments.
- 7. [Song] (Select -) button**
This displays the Song Select screen (p. 23). The song genre is switched each time you press this button while the Song Select screen is displayed (p. 25).
When the Function screen is displayed, this button is used to select the item for which settings are to be made (p. 88).
- 8. [◀◀] (Select +) button**
Press this button while the Song Select screen is displayed to select the previous song (p. 26, p. 28, p. 31).
When the Function screen is displayed, this button is used to select the item for which settings are to be made (p. 88).
- 9. [▶/■] (Value -) button**
Press this button while the Song Select screen is displayed to start and stop playback of the song (p. 26, p. 28, p. 31).
Press this button while the Function screen is displayed to change the value of a setting (p. 88).
- 10. [▶▶] (Value +) button**
Press this button while the Song Select screen is displayed to select the next song (p. 26, p. 28, p. 31).
Press this button while the Function screen is displayed to change the value of a setting (p. 88).
- 11. [Moving Key] (Enter) button**
This switches the automatic keyboard feature on and off (p. 88). This feature provides keyboard movement corresponding to the song being played back.
Additionally, press this button when the Function screen is displayed to make even more advanced settings.

Jack Panel (Front)

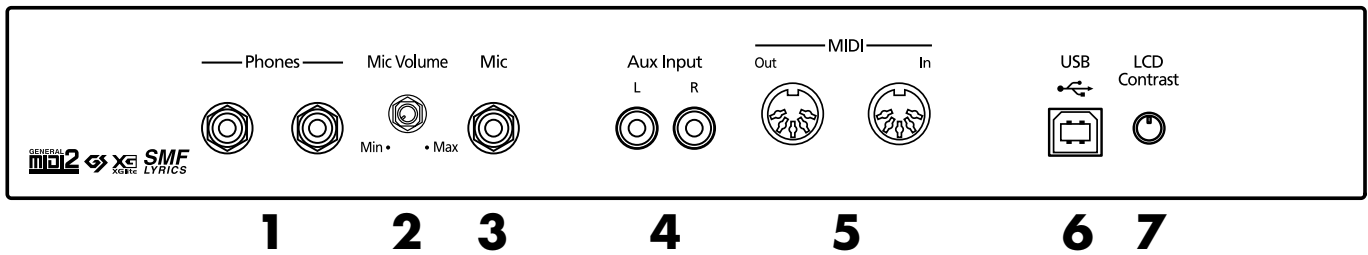

Jack Panel (Rear)

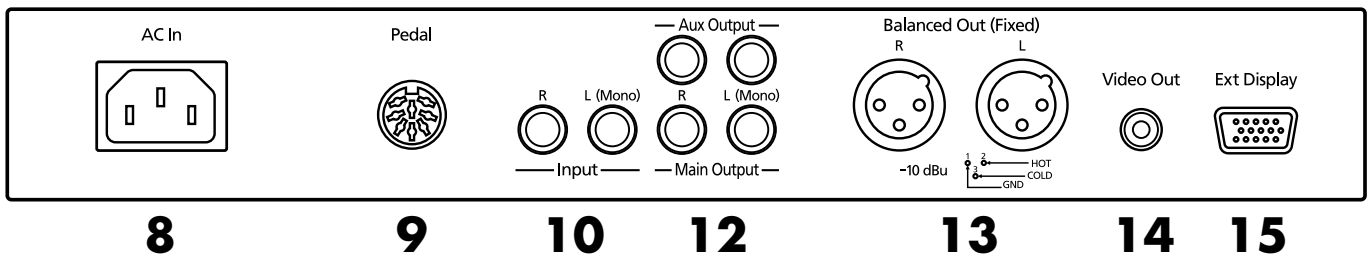

Jack Panel (Left Side of Bottom Panel)

1. Phones jacks

A set of headphones can be connected here (p. 21).

2. Mic Volume knob

Adjusts the volume level for the microphone (p. 21).

3. Mic jack

Used for connecting microphones (p. 21).

4. Aux Input jack

You can connect other sound generating devices or audio equipment here and have their sound be played through the RG-7's speakers (p. 36).

5. MIDI Out/In connectors

Connect to external MIDI devices to exchange performance data (p. 99).

6. USB connector

You can connect a computer and exchange performance data between the instrument and the computer (p. 103).

7. LCD Contrast knob

This adjusts the brightness of the front panel display (p. 23).

8. AC Inlet

Connect the included power cord to this inlet (p. 19).

9. Pedal connector

Connect the pedal cord here (p. 19).

10. Input jacks

You can connect other sound generating devices or audio equipment here and have their sound be played through the RG-7's speakers (p. 97).

11. Aux Output jacks

You can connect amps and external speakers here and play accompaniment or surround sound (p. 98).

12. Main Output jacks

These jacks can be connected to your audio system to enjoy more powerful sound (p. 97).

13. Balanced Out (Fixed) jacks

This provides balanced audio signal output. Connect a mixer or other such device here (p. 97).

14. Video Out jack

Connect a television here. This allows you to display the Song Select screen, slide show, lyrics, and notations on the connected television set (p. 49).

15. Ext Display connector

Connect a external display here. You can display the Song Select screen, slide show, lyrics, and notations on the external display (p. 47).

Panel Descriptions

CD Drive

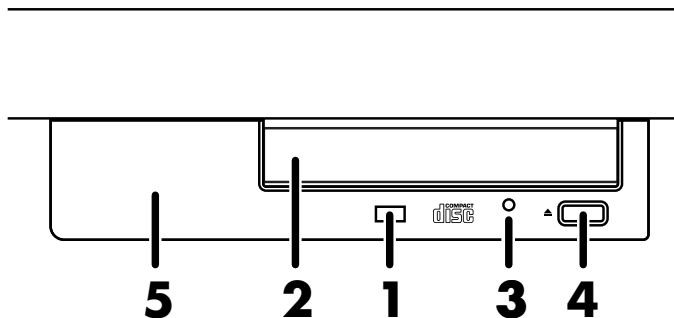

Bottom of CD Drive

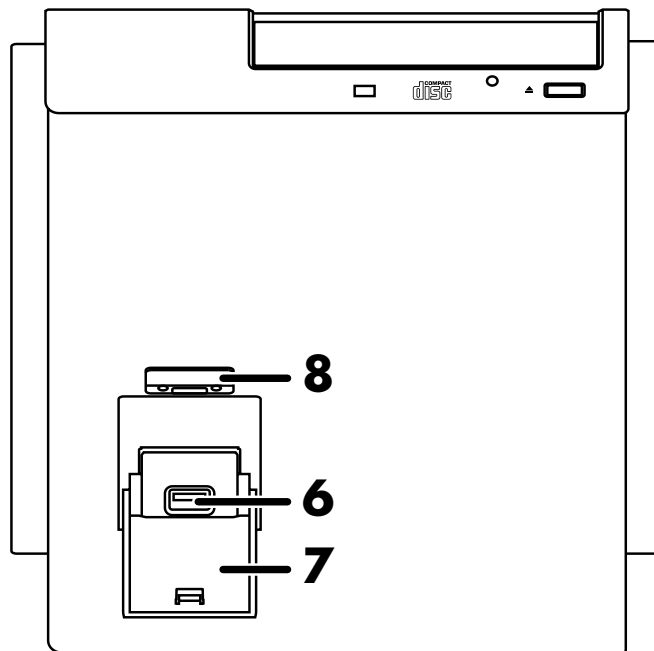

CD Drive (Right Side of Bottom Panel)

1. Access Indicator

This indicator will light when the inserted CD is being read.

2. Disc Tray

Place the CD to be loaded on this tray (p. 29).

3. Emergency Eject Hole

This hole allows the disc tray to be opened in case of an emergency (p. 29).

4. Eject Button

Press this button to eject the CD (p. 29).

* You cannot eject the CD unless the RG-7's power is turned on.

5. Infrared Receiver

Point the remote control at this sensor when using the remote control to operate the RG-7 (p. 33).

6. Ext Memory Port

You can connect USB memory (sold separately) here (p. 22).

7. Ext Memory Port Cover

You can ensure the cover remains closed when you have USB memory connected (p. 22).

* Be sure to close the cover of the Ext Memory port after connecting USB memory to the Ext Memory port. If the cover is left open, someone could get hurt if their legs bump into it; the cover could be damaged as well.

8. Ext Memory Port Cover Lock

You can lock the Ext Memory port cover to prevent theft of the USB memory device connected to the Memory port (p. 22).

Before You Start Playing

Opening and Closing the Top

Opening only the front top

⚠️ WARNING

Children must not be permitted to open or close the top on their own—adult supervision is required. Because the top is very heavy, always use two or more people when opening and closing the top, and be sure to handle it carefully.

1. Lift the right front (the upper note side: A in the figure) of the board with both hands, fold it back, and then lay it down slowly on the top.

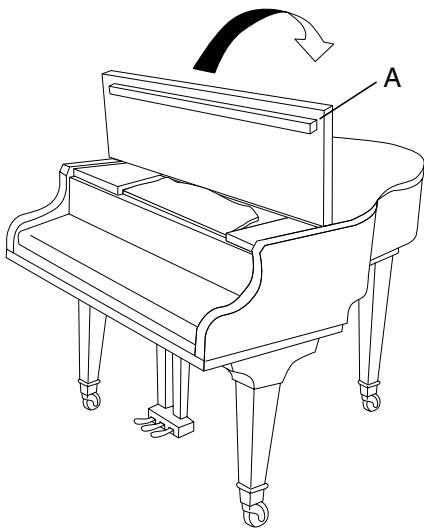

Opening both the front top and the top

2. Follow Step 1 to open the front top. Then lift the right front (the upper note side B: in the figure) of the board with both hands.

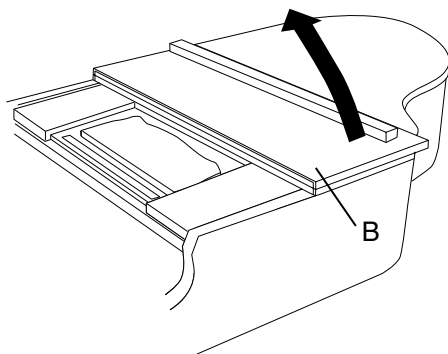

3. While holding up the top with one hand, lift up the top stick and insert its end into the appropriate top slip.

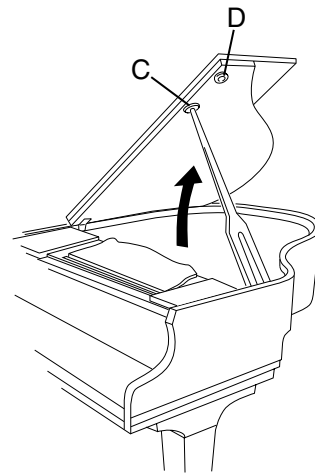

⚠️ CAUTION

Do not move the piano with the top in the open position. The top stick may disengage from the socket, causing the top to fall.

⚠️ WARNING

When opening the top, be careful not to open it too far. Opening the top at an angle in excess of 30 degrees may damage the unit, or cause the top to drop. Also, before opening the top, make sure that no one is in the path of the top as it is opened.

About the Topsticks and Topslip

The RG-7 has two topsticks, each a different length.

You can use the different topsticks to change the amount the top is left open.

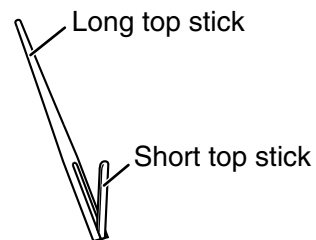

The following describes the fitting of the lid props and their corresponding topslips.

The long top stick: for inner top slip (C)

The short top stick: for outer top slip (D)

⚠️ CAUTION

If you use the wrong top slip, the top stick could slip out of the top slip, causing the top to fall. Make sure that the end of the top stick is inserted securely into the top slip.

To close the top, reverse the opening procedure.

Before You Start Playing

Raising the Music Rest

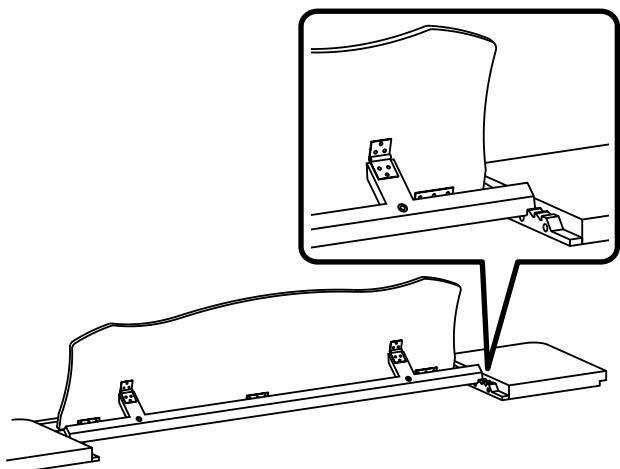

1. Open the front top (p. 17).
2. Hold the music rest with both hands, then raise it forward.
3. While supporting the music rest with one hand, adjust the angle of the music rest with the brace behind the music rest.

■ Extending the Music Rest

The music rest can be pulled forward to make your sheet music easier to read.

1. When extending the music rest, be sure to grasp the music rest with both hands and gently pull it forward.

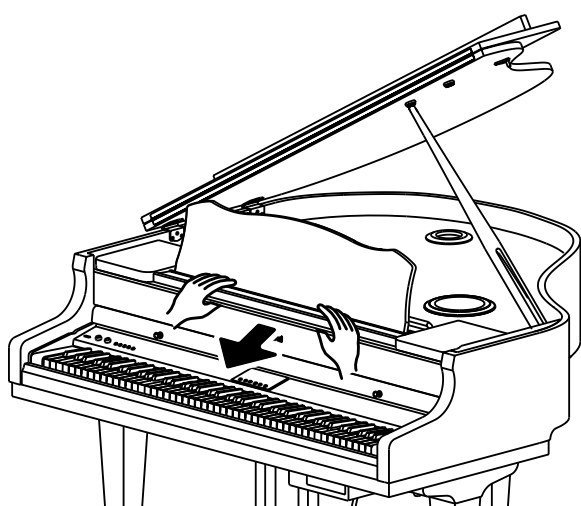

⚠ CAUTION

Pulling the music rest too far forward may cause it to separate and fall; be sure not to overextend the music rest.

Opening and Closing the Lid

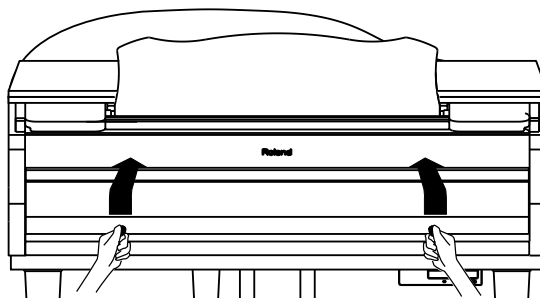

1. To open the lid, hold handles with both hands and lift it straight up. Then, slide it to the rear.
2. To close the lid, hold handles with both hands and slowly pull it forward until it stops. Then, gently lower it into place.

⚠ CAUTION

When opening and closing the lid, be careful not to let your fingers get caught. Small children should use it only under the supervision of an adult.

⚠ CAUTION

When moving the piano, for safety's sake be sure to close the lid first.

NOTE

Make sure you don't have anything (such as sheet music) on the keyboard when you close the lid.

■ Using the Lid Lock

You can lock the keyboard lid with the lid covering the control panel (front panel) to prevent it from being opened, thus avoiding inadvertent changes during automatic performances.

1. Lower the lid until the control panel (the front panel) is covered.
2. Turn the lid lock under the piano as shown in the figure below to lock the lid.

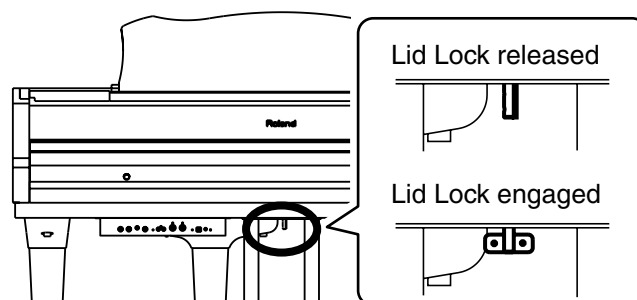

NOTE

Using undue force to open the lid when it is locked may damage the lid and/or the lock.

CAUTION

Turning the lid lock when the lid lock is released while the keyboard lid is open may make the keyboard lid prone to closing. Always confirm that the keyboard lid is covering the control panel before locking the lid.

Connecting the Pedal Cord

1. Connect the pedal cord to the Pedal jack located in the jack panel on the lower left of the RG-7.

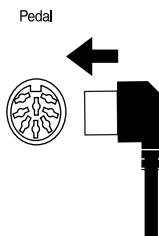

Connecting the Power Cord

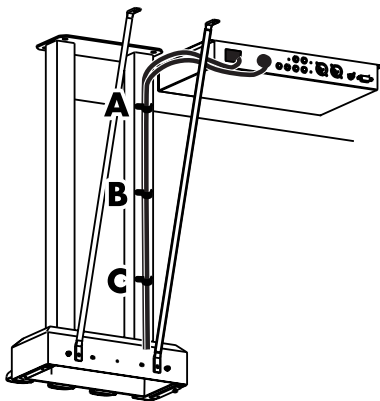

1. Connect the supplied power cord to the AC inlet.
2. Connect the pedal cord to the Pedal connector.
3. Cramp the power cord and pedal cord with Cord Cramp (b) and screw (a) at A, B, and C (see the picture above).

(a) Screw



(b) Cord Cramp



4. Plug the power cord into an AC outlet.

Turning the Power On and Off

NOTE

Turn on power to your various devices in the order specified. By turning on devices in the wrong order, you risk causing malfunction and/or damage to speakers and other devices.

To turn the power on, turn the [Volume] knob all the way down, and then press the [Power] switch.

When you turn on the power to the RG-7, the front panel display appears as shown below.

Roland Digital Grand
RG-7

After a few seconds, you will be able to play the keyboard to produce sound.

Use the [Volume] knob to adjust the volume.

NOTE

This unit is equipped with a protection circuit. A brief interval (a few seconds) after power up is required before the unit will operate normally.

To turn the power off, turn the [Volume] knob all the way to the left, and press the [Power] switch.

The front panel display goes blank, and the power is turned off.

* If you need to turn off the power completely, first turn off the POWER switch, then unplug the power cord from the power outlet. Refer to "Power Supply" (p. 6).

Before You Start Playing

Adjusting the Sound's Volume and Brilliance

Turn the [Volume] knob to adjust the overall volume.

Turn the [Brilliance] knob to adjust the brightness of the sound.

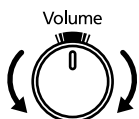

MEMO

The mark at the top of the [Volume] knob indicates the volume level typically produced by an acoustic piano. This is usually the most appropriate volume for your piano performances.

MEMO

You can adjust the volume with the remote control. For details, refer to "About the Remote Control" (p. 34).

About the Pedals

The pedals have the following functions, and are used mainly for piano performance.

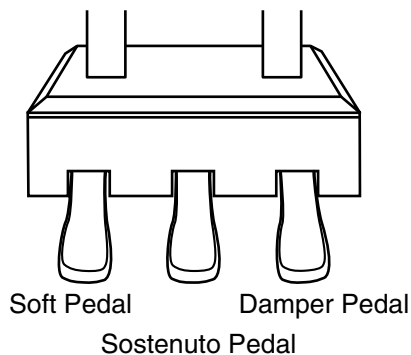

Damper pedal (right pedal)

While this pedal is pressed, notes will be sustained even after you take your fingers off the keys.

On an acoustic piano, holding down the damper pedal will allow the remaining strings to resonate in sympathy with the sounds that you played from the keyboard, adding a rich resonance.

The RG-7 simulates this Damper Resonance.

MEMO

You can change the amount of resonance applied with the damper pedal. Please refer to "Producing the Resonance of the Strings When the Keys Are Played (Damper Resonance)" (p. 59).

Sostenuto pedal (center pedal)

This pedal sustains only the sounds of the keys that were already played when you pressed the pedal.

Soft pedal (left pedal)

When you hold down this pedal and play the keyboard, the sound will have a softer tone.

The softness of the tone can be varied subtly by the depth to which you press the pedal.

MEMO

You can assign functions to the left and center pedals. Refer to "Assigning Functions to Pedals" (p. 69).

Connecting Headphones

The RG-7 has two jacks for plugging in headphones. This allows two people to listen through headphones simultaneously, making it very useful for lessons and performing piano pieces for four hands. Additionally, this allows you to play without bothering others around you, even at night.

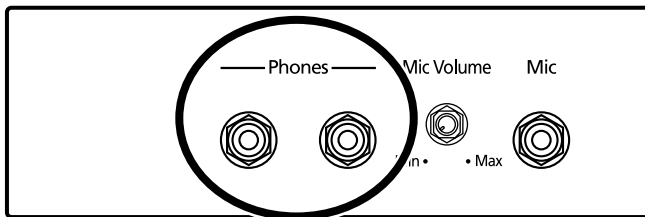
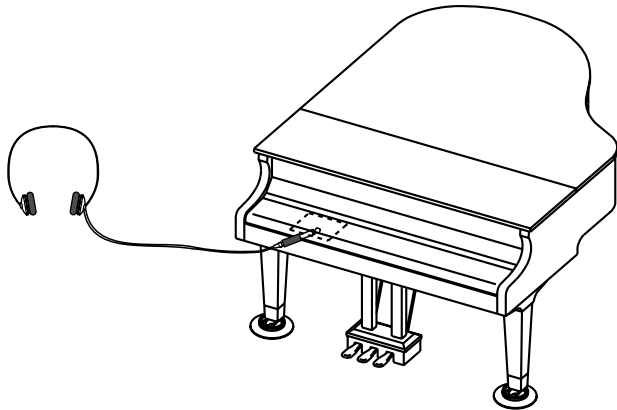

1. Plug the headphones into the Phones jack located in the jack panel on the lower left of the RG-7.

Connecting headphones will automatically mute the sound from the internal speakers.

The headphone volume is adjusted by the [Volume] knob of the RG-7.

NOTE

Use Stereo headphones.

Some Notes on Using Headphones

- To prevent damage to the cord, handle the headphones only by the headset or the plug.
- Connecting the headphones when the volume of connected equipment is turned up may result in damage to the headphones. Lower the volume on the RG-7 before plugging in the headphones.
- Listening at excessively high volume levels will not only damage the headphones, but may also cause hearing loss. Use the headphones at a moderate volume level.

Connecting a Microphone

You can connect a microphone into the Mic jack, and enjoy karaoke with the RG-7.

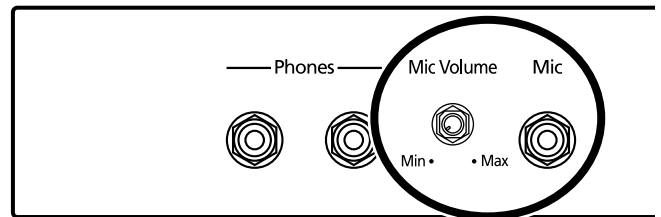
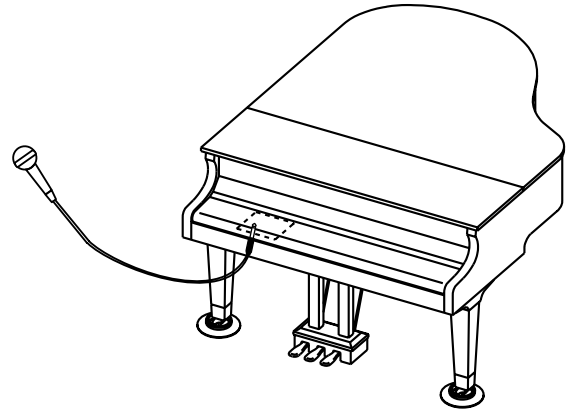

1. Connect a microphone (sold separately) to the Mic jack located in the jack panel on the lower left of the RG-7.
2. Rotate the Mic Volume knob in front of the Mic jack to adjust the volume level for the microphone.
3. Adjust the mic echo (p. 39).

Some Notes on Using a Microphone

- Be careful of high volume levels when using microphone late at night or early in the morning.
- When connecting a microphone to the RG-7, be sure to lower the volume. If the volume control is too high when the microphone is plugged in, noise may be produced by the speakers.
- Howling could be produced depending on the location of microphones relative to speakers. This can be remedied by:
 - Changing the orientation of the microphone.
 - Relocating microphone at a greater distance from speakers.
 - Lowering volume levels.

Before You Start Playing

Connecting USB Memory

You can connect USB memory (sold separately) to the RG-7's Ext Memory port. Connecting external USB memory enables you to do the following:

- Play back songs stored on the USB memory device.
- Save songs recorded on the RG-7 to the USB memory device.
- Copy songs in the USB memory device to the RG-7's User memory, allowing the songs to be called up simply and easily.
- The images saved to the USB memory are displayed as a slide show.

■ Connecting the Memory

NOTE

Always be sure to use the following procedure when connecting USB memory.

1. Press the Ext Memory port cover located under the CD drive to open the cover.

Press the front of the cover to open it.

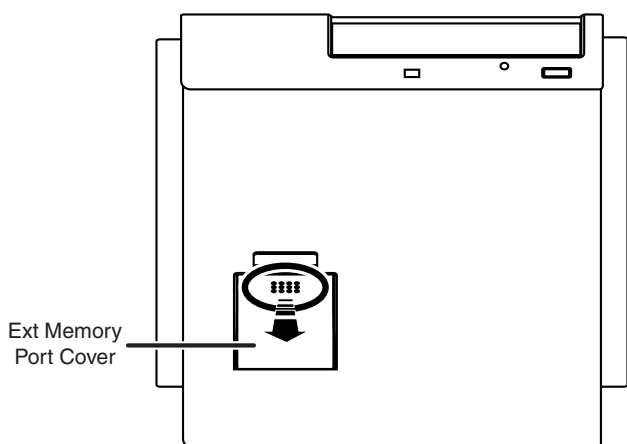

2. Connect the USB memory to Ext Memory port.

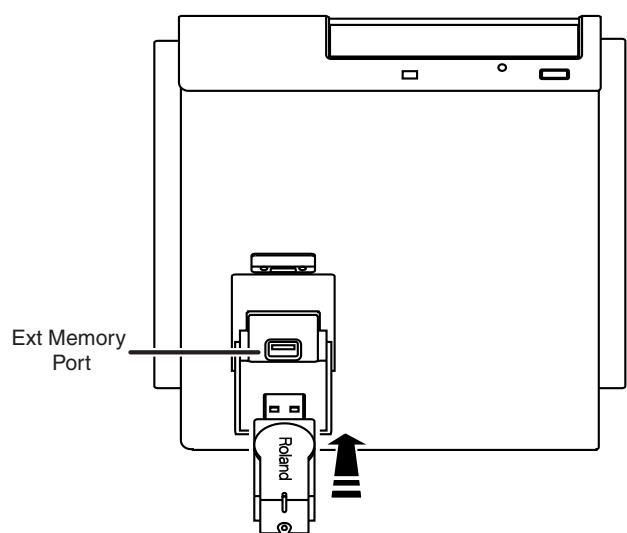

3. Press on the front part of the Ext Memory port cover to close the cover.

NOTE

Use USB memory available from Roland. Proper operation cannot be guaranteed if other external memory products are used.

Locking the Ext Memory Port Cover

You can lock the Ext Memory port cover to prevent theft of the USB memory device (sold separately) connected to the Ext Memory port.

1. Connect the USB memory device (refer to previous section).
2. Press on the front part of the Ext Memory port cover to close the cover.

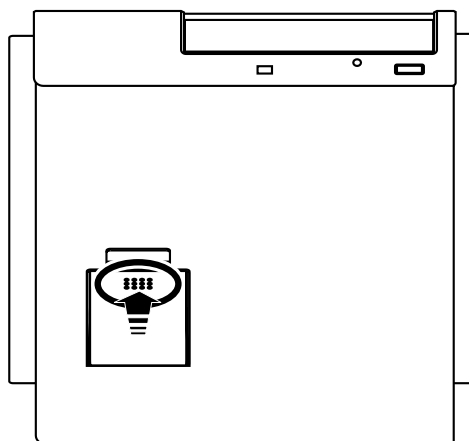

3. Using a screwdriver, remove the anti-theft lock screws (two screws) to the side of the Ext Memory port.

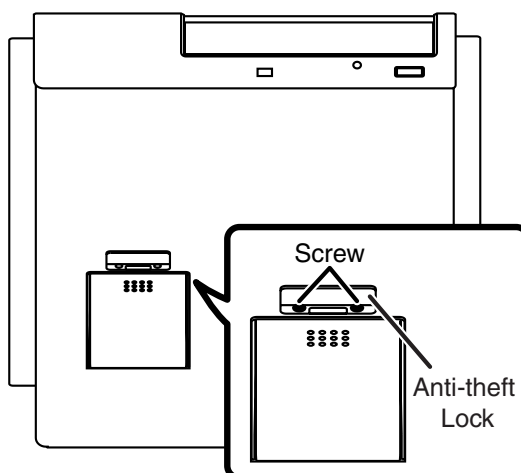

4. Secure the anti-theft lock with the screws as shown below.

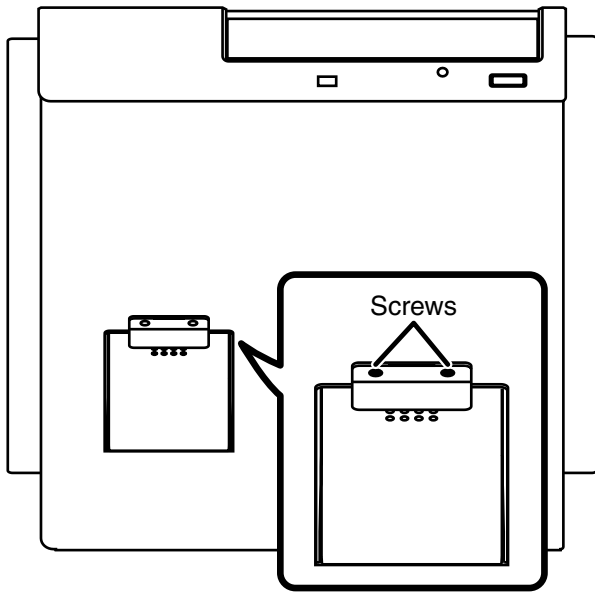

NOTE

Be sure to replace removed screws when securing the anti-theft lock.

About the Screens

Immediately after the power is turned on, the Song Select screen like the one below is displayed.

■ Main Screens

Song Select Screen

When you press the [Song] button, the following screen is displayed. Each time you press the [Song] button in this screen, the song genre is switched.

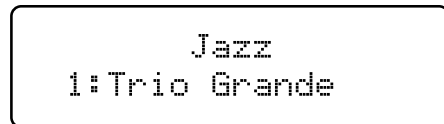

Function Screen

Press the [Function] (Exit) button; the indicator lights, and the following screen appears.

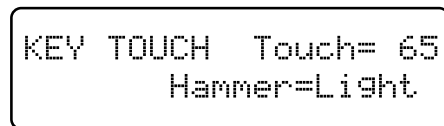

Tone Screen

Press the Tone button; the indicator lights, and the following screen appears.

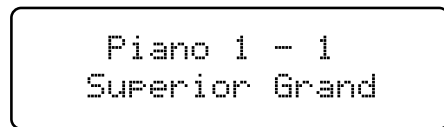

■ Adjusting the Contrast of the Screen

1. Rotate the LCD Contrast knob on the jack panel at the lower left of the instrument.

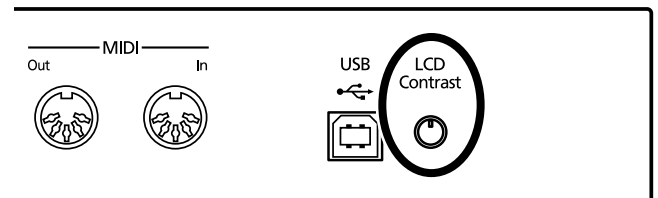

Chapter 1. Playing Back Songs

Look at What You Can Do with the RG-7!

Listen to the Internal Songs

The various internal songs programmed in the RG-7 are categorized into “Jazz” and “Classical” genres. You can play back the songs in these genres in a variety of ways, playing all the songs in sequence or randomly, or just playing songs individually.

Listen to the Included CD and Commercial Audio CDs

You can use the RG-7’s CD drive to play the included CD, CD-ROMs containing saved SMF music files, commercial audio CDs, and player piano CDs.

Listen to Songs Saved to USB Memory

Not only can you play CDs, you can also play back SMF music files saved on USB memory. In addition, you can connect USB memory and copy song data recorded with the RG-7 to the USB memory.

Store Songs in the “Favorites”

The RG-7 is set at the factory with tone demos registered in the “Favorites.” Listen to the tone demos to check out the special characteristics of each tone.

Additionally, you can save songs recorded with the RG-7 to the “Favorites” and you can copy songs stored in USB memory to the “Favorites” as well. Songs held in the “Favorites” are not lost when the power is turned off, making this a convenient place to store those songs you listen to often.

Easy-to-Use Remote Control Included

You can use the included remote control to start and stop the current performance and switch songs. You can also use the remote control to select what is to be displayed on an external screen or television set connected to the RG-7 and assign other functions to the remote control’s buttons to make operating the RG-7 even simpler.

Connect a Microphone for Karaoke Performances

Connect a microphone to the RG-7, and you are ready to enjoy karaoke. You can change the key of the song to match the singer’s voice and adjust the amount of echo applied to the microphone input. In addition, the RG-7 includes functions for adding harmonies and effects (Transformer) to vocals.

Show Your Favorite Images on a Connected Display or Television

You can connect an external display or television set to the RG-7 and display the Song Select screen, lyrics and notations, and even slide shows of your favorite images. You can also use the remote control to switch the images appearing in the connected external display or television.

The “Moving Key” Feature

You can have the RG-7’s keyboard play automatically along with the internal songs, songs recorded with the RG-7, songs on CDs, and songs stored in USB memory. You can switch this feature on and off with the [Moving Key] button on the front panel or with the buttons on the remote control.

Listening to Songs

The RG-7 features a variety of internal songs. The internal songs are categorized into “Jazz” and “Classical” genres.

You can also use the RG-7’s CD drive to play back the included CD, CD-ROMs with songs saved in SMF format, commercially available audio CDs, and player piano CDs. Moreover, you can connect USB memory to the Ext Memory port and play back SMF music file that’s been saved on the memory device.

■ [Song] Button Functions

Each press of the [Song] button selects the next available song genre, in this order: “Jazz” → “Classical” → “Favorites” → “CD” → “Ext Memory” (songs in the USB memory device connected to the Ext Memory port)

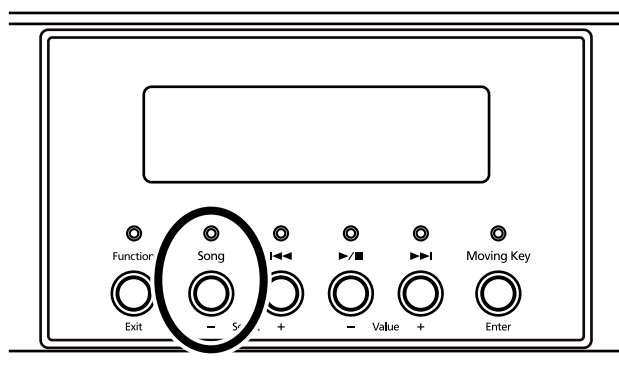

The “CD” and “USB” genres appear only when a CD is in the CD drive or when USB memory is connected to the Ext Memory port. “Favorites” is indicated only when there are songs in the Favorites genre.

What are the “Favorites?”

This is the area of memory where you can save copies of performances recorded with the RG-7, songs saved on CD-ROMs, songs stored in the USB memory connected to the RG-7’s Ext Memory port, and other songs.

After copying songs to the “Favorites,” you can then select the copied songs simply by pressing the [Song] button and selecting “Favorites” as the song genre.

The RG-7 features a User Memory (the RG-7’s memory) area where the following types of data are stored.

- Content registered in the “Favorites”
- Content set in User programs (Favorites performance settings) (p. 78)

To delete the content of the User Memory and restore the memory to the default factory settings, refer to “Initializing the User Memory or USB Memory” (p. 92).

You can select and listen to tone demos (p. 26) from the “Favorites” after initializing the User memory.

You can also delete these tone demos and overwrite them with other songs, which can then be saved.

Chapter 1. Playing Back Songs

■ Listening to the Tone Demos

The factory settings have tone demos registered in the “Favorites” (p. 25).

1. Press the [Song] button one or more times to select “Favorites” as the genre.
2. Press the [▶/■] button to start playback of the tone demos.

You can select the tone demo to play back by pressing the [◀◀] or [▶▶] button.

3. Press the [▶/■] button once more to stop playback of the tone demos.

You can delete tone demos in the “Favorites” and overwrite them by saving other songs in their place. If you want to play back tone demos after they have been deleted, initialize the User Memory to restore the factory settings (p. 92).

■ Listening to the Internal Songs

1. Press the [Song] button one or more times to select the genre you want.

The internal song genres are “Jazz” and “Classical.”

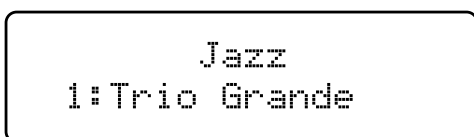

If using the remote control, press the remote control’s [INTERNAL] button. The internal song genre selection can be switched between “Jazz” and “Classical” by pressing the [INTERNAL] button.

“Jazz” → “Classical” → “Jazz”....

2. Press the [▶/■] button to start playback of the internal songs.

Songs in the selected genre are played back.

When the RG-7 is set to play back all songs (p. 27), once the song currently being played back is finished, the next song starts playing automatically. After all of the songs in the genre have been played, playback automatically resumes from the first song in the genre. When the RG-7 is set to play back a single song (p. 27), playback stops automatically when the song is finished.

You can select the next song by pressing the [▶▶] button, and return to the beginning of the song or the previous song by pressing the [◀◀] button.

3. Press the [▶/■] button once more to stop playback of the internal songs.

NOTE

Songs saved to the “Favorites” are deleted when the User Memory is initialized. Save any songs you want to retain by copying them to USB memory (p. 42).

MEMO

For more information on the [Song] button functions, refer to “[Song] Button Functions” (p. 25).

NOTE

If any previously recorded song data is present, the message “Delete User Song OK?” appears in the display. If you want to delete the existing song data, press the [Moving Key] (Enter) button. If you do not want the song data to be deleted, press the [Function] (Exit) button, and save the song to the “Favorites” or to your USB memory (p. 76).

MEMO

When playing songs on CDs, refer to “Listening to Songs on CDs” (p. 28).

MEMO

When playing songs from a USB memory device connected to the Ext Memory port, refer to “Playing Back Songs from USB Memory” (p. 31).

Playing Back One Song

To play a single selected song, use the following procedure.

1. Press the [Function] (Exit) button, getting its indicator to light.
2. Press the [Song] (Select -) button or [◀◀] (Select +) button to display the PLAY screen.



3. Press the [Song] (Select -) button or [◀◀] (Select +) button to get the value for "Mode" to flash.



4. Press the [▶/■] (Value -) button or [▶▶] (Value +) button to select "One Song."

Value	Description
All Song	All of the songs in the genre are played back in sequence, starting from the selected song. When the final song in the selected genre is finished playing, playback then automatically resumes from the first song in that genre.
One Song	Only the selected song is played. Playback stops when the song is finished.

5. Press the [Function] (Exit) button so the indicator goes out.

MEMO

You can save this setting in the RG-7's memory using the Memory Backup function (p. 72).

Chapter 1. Playing Back Songs

■ Listening to Songs on CDs

Cautions

Handling CDs

- Do not leave discs exposed to direct sunlight for extended periods.
- Handle CDs with your finger and thumb, holding the disc by the center hole and outer rim. Do not touch or scratch the disc's recording surface (the green side).
- Do not drop or stack discs.
- Do not place heavy objects on discs or subject them to strong impact.
- Do not affix stickers or other such materials on the label side. Placing stickers on the disc may result in errors when data writing and scratch the disc.
- Use a felt-tip marker or other soft-tipped implement to write titles and other information on the label side of discs.
- Store discs in their original cases or other suitable cases for protection.
- Before using the CD, please read the warning on the CD cover.

Cleaning Discs

- If a disc becomes dusty or soiled, gently wipe the disc with a soft cloth. Always wipe outwards from the center using light, gentle strokes. Do not wipe the disk in a circular pattern.

Precautions Concerning Use of the CD

- CD-R/RW discs to which audio tracks have been added, and CDs with mixed audio tracks and data will not play back properly.
- The RG-7 is capable of playing back only commercial CDs that conform the official standards—those that carry the “COMPACT DISC DIGITAL AUDIO” logo. The usability and sound quality of audio discs that incorporate copyright protection technology and other non-standard CDs cannot be guaranteed.
- For more detailed information on audio discs featuring copyright protection technology and other non-standard CDs, please consult the disc vendor.
- You cannot save songs and styles to CDs, and you cannot delete songs or styles recorded to CDs. Furthermore, you cannot format CDs.
- The prescribed format for CD-R/RW discs is “ISO9660 Level 1 Mode 1.”
- You may be unable to read using other formats.

CDs That Can Be Played Back

- Commercially available audio CDs
- CD-ROMs containing saved SMF music files
- CD included with the RG-7
- Player piano CDs

Insert the CD in the CD Drive

1. Press the eject button and open a disc tray.

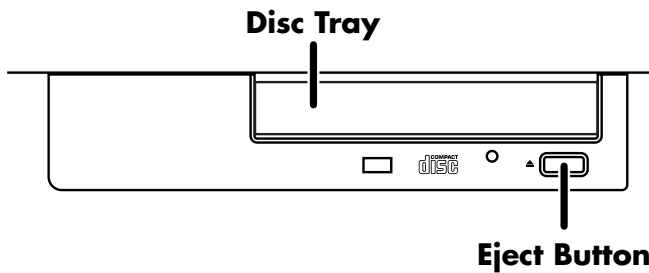

2. Put a CD on a disc tray.
3. Press the eject button again to close the disc tray.

Removing a CD

1. Press the eject button and open a disc tray.
2. Remove the CD from the disc tray.

If a disc tray does not open

If the power is turned off with the disc still in the drive (such as due to a power failure), the disc tray cannot be opened by pressing the eject button. In this case, you can insert a piece of wire to force the tray open.

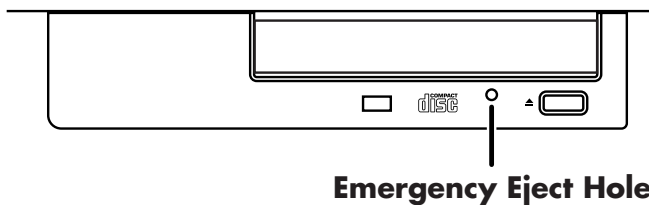

Make sure the RG-7's power has been turned OFF before attempting to engage the emergency eject hole. If you insert something while the power is on, the disc could be damaged, or unexpected problems may occur.

Playing Back Songs on CDs

You can play back the CD included with the RG-7, CDs with player piano CDs, audio CDs, and CD-ROMs to which SMF music files are saved.

1. Place the CD you want to play in the CD drive.
2. Press the [Song] button one or more times to select "CD" as the genre.

If using the remote control, press the remote control's [EXTERNAL] button, then select "CD" as the genre.

Chapter 1. Playing Back Songs

The following screen appears.

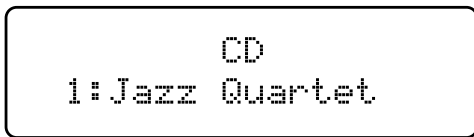

3. Press the [▶/■] button to start playback of the CD's songs.

The songs on the CD are played.

When the RG-7 is set to play back all songs (p. 27), once the song currently being played back is finished, the next song starts playing automatically. After all of the songs on the CD have been played, playback automatically resumes from the beginning of the CD. When the RG-7 is set to play back a single song (p. 27), playback stops automatically when the song is finished.

You can select the next song by pressing the [▶▶] button, and return to the beginning of the song or the previous song by pressing the [◀◀] button.

4. Press the [▶/■] button once more to stop playback of the songs.

When Selecting Songs in a Folder

1. Press the [◀◀] button or [▶▶] button to select a folder.
2. Press the [▶/■] button.
3. Press the [◀◀] button or [▶▶] button to select a song.

* Depending on the number of songs contained in a folder, this may take some time.

If a Folder Contains Further Folders and Song Data

If yet other folders are contained within a folder, this is indicated in following manner.

1. Press the [◀◀] button to display "Song No. 1."
2. Press the [◀◀] button.

The name of the folder appears in the screen.

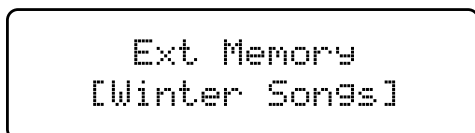

If a folder contains other folders, press the [◀◀] button to switch the screens.

3. Press the [▶/■] button.

The first song in the folder is displayed.

To exit a folder:

1. Press the [◀◀] button one or more times until "↑ Up" appears in the screen.
2. Press the [▶/■] button.

NOTE

If any previously recorded song data is present, the message "Delete User Song OK?" appears in the display. If you want to delete the existing song data, press the [Moving Key] (Enter) button. If you do not want the song data to be deleted, press the [Function] (Exit) button, and save the song to the "Favorites" or to your USB memory (p. 76).

MEMO

You can start and stop playback of songs on CDs with the remote control's [▶/■] button. You can also use the remote control's [▶▶] button to advance to the next song and [◀◀] button to select the previous song.

MEMO

If you want to playback at each song, refer to "Playing Back One Song" (p. 27).

■ Playing Back Songs from USB Memory

Not only can you listen to the songs on CDs, but you can also listen to songs saved on USB memory devices connected to the Ext Memory port.

- 1.** Connect the USB memory device containing the songs you want to play to the Ext Memory port.
- 2.** Press the [Song] button one or more times to select “Ext Memory” as the genre.

If using the remote control, press the remote control’s [EXTERNAL] button, then select “Ext Memory” as the genre.

The following screen appears.

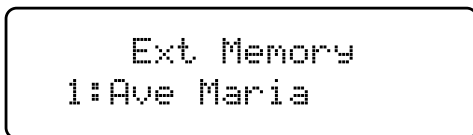

- 3.** Press the [▶/■] button to start playback of the USB Memory’s songs.

The songs stored in the USB memory are played.

When the RG-7 is set to play back all songs (p. 27), once the song currently being played back is finished, the next song starts playing automatically. After all of the songs on the USB memory have been played, playback automatically resumes from the beginning of the USB memory.

When the RG-7 is set to play back a single song (p. 27), playback stops automatically when the song is finished.

You can select the next song by pressing the [▶▶] button, and return to the beginning of the song or the previous song by pressing the [◀◀] button.

- 4.** Press the [▶/■] button once more to stop playback of the songs.

NOTE

Use USB memory available from Roland. Proper operation cannot be guaranteed if other external memory products are used.

NOTE

If any previously recorded song data is present, the message “Delete User Song OK?” appears in the display. If you want to delete the existing song data, press the [Moving Key] (Enter) button. If you do not want the song data to be deleted, press the [Function] (Exit) button, and save the song to the “Favorites” or to your USB memory (p. 76).

MEMO

You can start and stop playback of songs saved on USB memory with the remote control’s [▶/■] button. You can also use the remote control’s [▶▶] button to advance to the next song and [◀◀] button to select the previous song.

MEMO

If you want to playback at each song, refer to “Playing Back One Song” (p. 27).

Using the Remote Control

You can use the included remote control to easily start and stop performances and switch songs. You can also use the remote control to select what is to be displayed on an external screen or television set connected to the RG-7 and assign functions to the buttons used in operating the remote control.

■ Installing Batteries in the Remote Control

Install the batteries provided in the remote control.

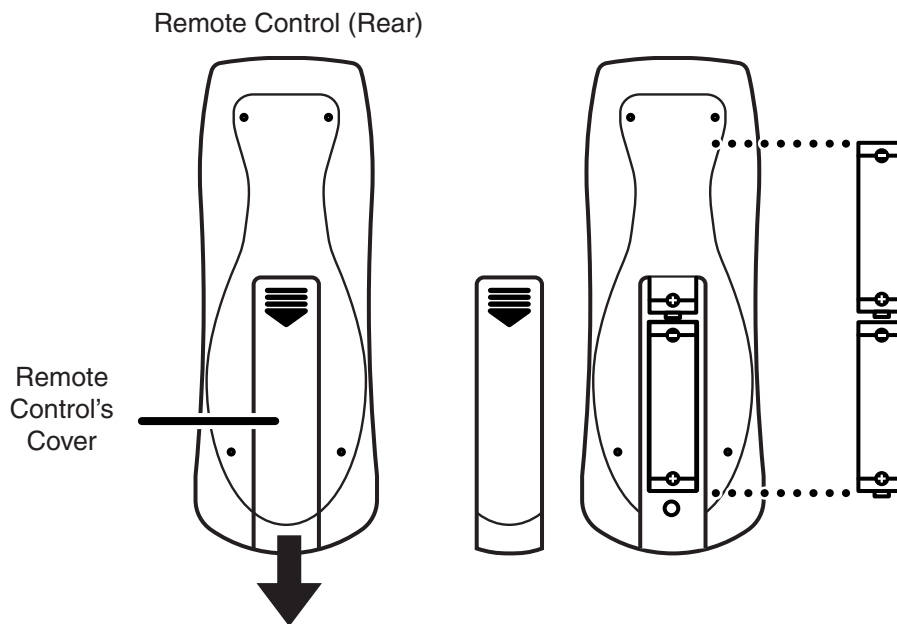

- 1.** Open the battery cover on the back of the remote control.
- 2.** Insert the supplied AA batteries, as shown in the figure of remote control.
- 3.** Close the battery cover.



For more information on the remote control button functions, refer to "About the Remote Control" (p. 34).

NOTE

Be careful to observe the correct polarity (+, - direction) when installing the batteries.

■ How to Use the Remote Control

When using the remote control, aim the remote control at the infrared receiver, keeping in mind the range of operation (below).

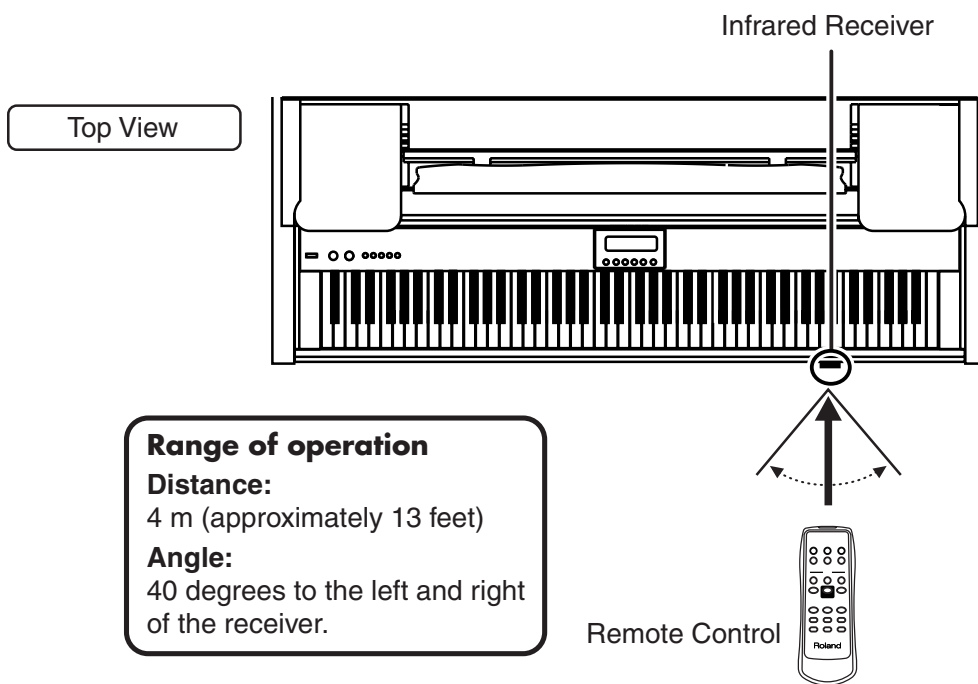
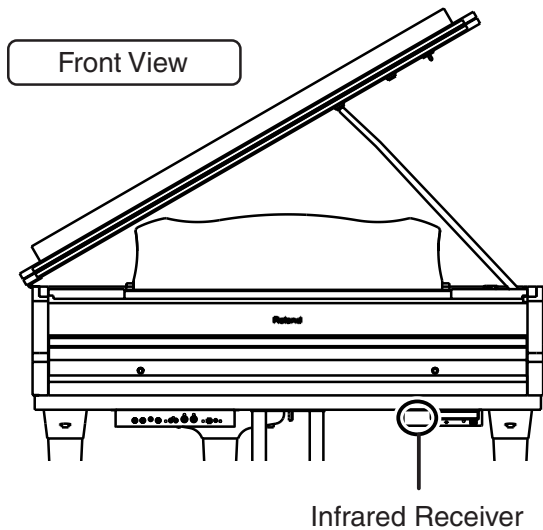





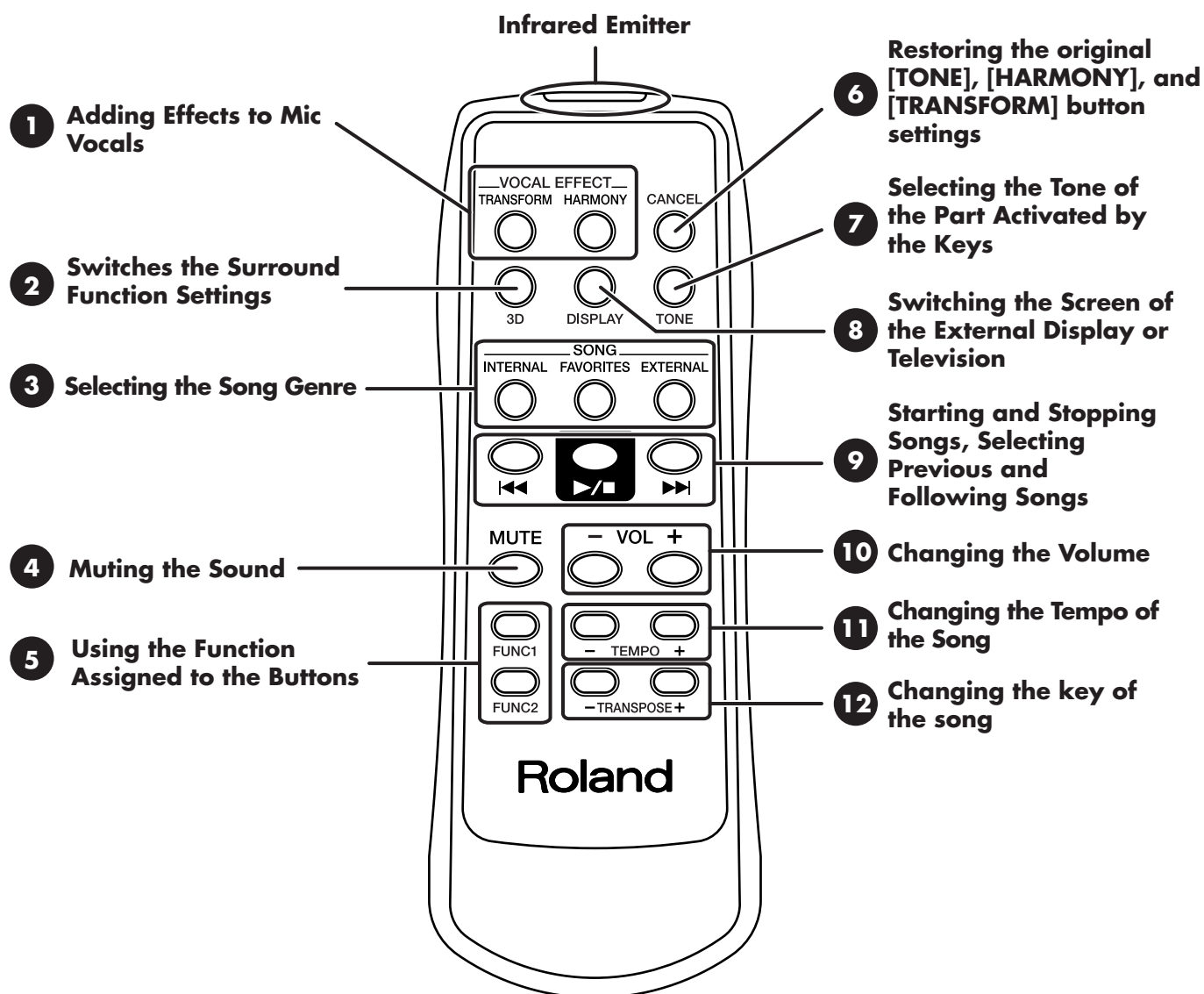

Precautions Concerning Use of the Remote Control

- The remote control is able to transmit only one operation at a time.
- The remote control may not operate even within the range of operation if there is an obstacle between it and the main unit.
- Using the remote control near other equipment that uses remote control systems may result in operational errors.
- The life of the battery depends on the amount and conditions of use. If the operational range of the remote control decreases, change the batteries.
- If you will not be using the remote control for a long period of time, remove the batteries.
- The responsiveness of the remote control may suffer if the remote control is within the glare of any spotlights or exposed to other strong light.

■ About the Remote Control



Button		Explanation
1	TRANSFORM	This changes the vocals from the microphone. You can also use this to change vocals on the CD included with the instrument (p. 41). The transform setting switches each time you press the button. "Male" → "Female" → "Kids" → "Off" → "Male"
	HARMONY	This adds harmonies to the mic vocals. You can also add harmonies to vocals on the included CD (p. 40). The harmony setting switches each time you press the button. "Data" → "Oct Up" (1 Octave Up) → "OctDwn" (1 Octave Down) → "Off" → "Data"
2	3D	Adds expansiveness and depth to the sound when it's played through external speakers (p. 98). The setting switches each time you press the button.

Button	Explanation
3	INTERNAL Selects the internal song genre. The internal song genre selection changes when the [INTERNAL] button is pressed. "Jazz" → "Classical" → "Jazz"
	FAVORITES Selects the "Favorites" genre. * This group cannot be selected if no songs have been saved to the "Favorites."
	EXTERNAL Selects the "CD" or "Ext Memory" genre. Pressing this button toggles you between selection of the "CD" and "Ext Memory" genre. * These groups cannot be selected if there is no CD in the CD drive or if no USB memory is connected.
4	MUTE This mutes all of the sounds. The Moving Key function stops at this time.
5	FUNC 1 You can use the function assigned to this button. You can also change the function assigned to the button (p. 90). With the factory settings, the Moving Keys On/Off is assigned to this button.
	FUNC 2 You can use the function assigned to this button. You can also change the function assigned to the button (p. 90). With the factory settings, the Random Playback On/Off is assigned to this button.
6	CANCEL This restores the remote control's [HARMONY] and [TRANSFORM] button settings to their original condition. The [TONE] button is set to piano tone.
7	TONE This changes the tone of the part activated by the keys. The tone is switched each time you press the button.
8	DISPLAY Switches the images appearing in the connected external display or television screen (p. 50). You can display the Song Select screen, lyrics, slide show (p. 51), and notations in the external display or television.
9	 When you press the [] button while the song is stopped, the previous song is selected. Pressing the [] button while a song is playing returns you to the beginning of that song.
	 This starts and stops playback of the song. Playback alternately starts and stops each time you press the [] button.
	 When you press the [] button, the next song is selected.
10	VOL [-] [+] (Volume) You can adjust the volume. Press the VOL [-] button to decrease the volume, and press the VOL [+] button to increase the volume.
11	TEMPO [-] [+] This adjusts the tempo. Press the TEMPO [-] button to slow down the tempo, and press the TEMPO [+] button to quicken the tempo. * You cannot change the tempos for audio CDs and Player Piano CDs.
12	TRANSPOSE [-] [+] Transposes the key of the song being played. Press the TRANSPOSE [-] button to lower the key; press the TRANSPOSE [+] button to raise the key. You can also assign functions to the button (p. 90).

Using the Aux Input Jack

1. Press the [Function] (Exit) button so the indicator is lit.
2. Press the [Song] (Select -) button or [◀◀] (Select +) button to display the AUX INPUT screen.
3. Press the [Song] (Select -) button or [◀◀] (Select +) button to get the value for "Mode" to flash.

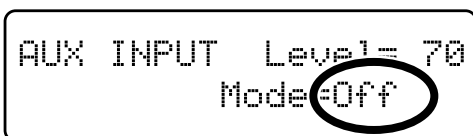

4. Press the [▶/■] (Value -) button or [▶▶] (Value +) button to change Aux Input type.

Value: **Off, Stereo, Decode**

With the factory settings, this is set to "Off." When set to "Off," the Aux Input connector cannot be used.

Set this to "Stereo" when using a connected MD player or other such device.

"Decode" is employed when inputting encoded signals; it is not normally used in normal situations.

5. Press the [Song] (Select -) button or [◀◀] (Select +) button to get the value for "Level" to flash.

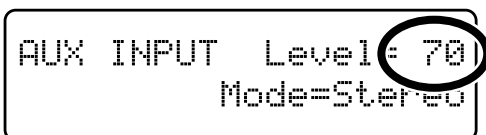

6. Press the [▶/■] (Value -) button or [▶▶] (Value +) button to change the Level of the device connected to Aux Input jack.

Value: **0-127**

* When the level is set to "0," sounds from the device connected to the Aux Input jack are not played.

7. Press the [Function] (Exit) button so the indicator goes out.



You can save this setting in the RG-7's memory using the Memory Backup function (p. 72).

Changing the Song Tempo

This changes the song tempo. Changing the tempo has no effect on the pitch of the notes. And you can change the tempo even when the song is in progress.

1. Press the remote control's TEMPO [-] or TEMPO [+] button to adjust the tempo of the song.

The tempo is indicated in the external display.

The tempo can be adjusted in a range of ♩=10–500.

You can also change the tempo during playback.

Pressing the TEMPO [+] button once increases the tempo by one unit. Holding down the button increases the tempo continuously. Pressing the TEMPO [-] button once decreases the tempo by one unit. Holding down the button makes the tempo change (slow down) continuously.

NOTE

You cannot change the tempos for audio CDs and Player Piano CDs.

Using the Karaoke Feature

You can connect a microphone to the RG-7 and enjoy singing along as the music data is played back.

1. Connect the USB memory device containing the songs you want to play to the Ext Memory port (p. 22).
2. Connect a microphone (p. 21).
3. Adjust the volume level and the amount of echo applied.

Adjust the microphone echo using the Mic Echo feature (p. 39).

You can also use the Harmony function (p. 40) to add harmony to vocals sung through the microphone or the Transformer effect (p. 41) to alter the sound of the microphone vocals.

4. Select a song (p. 26, 28, 31).
5. Adjust the tempo as required with the remote control Tempo [-] [+] buttons.
6. If necessary, change the key of the song (p. 38).
7. The song starts to play when you press the [▶/■] button.
Now sing along with the song.
8. Playback of the song stops when you press the [▶/■] button again.

MEMO

You can connect an external display or television to the RG-7 and have the lyrics of music data containing lyrics be displayed on the screen as the data is played back. Refer to “Connecting an External Display” (p. 47), “Connecting a Television” (p. 49), and “Selecting What is To Be Displayed on the External Display or Television” (p. 50).

■ Changing the Key of the Song Being Played (Playback Transpose)

SMF Music files or a performance that you recorded can be transposed for playback.

When using the karaoke feature, you can raise or lower the key of the song to match your own pitch.

1. Select a song to play back (p. 26, 28, 31).
2. Press the [Function] (Exit) button so the indicator is lit.
3. Press the [Song] (Select -) button or [◀◀] (Select +) button to display the TRANSPOSE screen.

```
TRANSPOSE  Link=On  
Keyboard/Playback= 0
```

4. Press the [Song] (Select -) button or [◀◀] (Select +) button to get the value for "Link" to flash.

```
TRANSPOSE  Link=On  
Keyboard/Playback= 0
```

5. Press the [▶/■] (Value -) button or [▶▶] (Value +) button to switch the Link setting to "On."
6. Press the [Song] (Select -) button or [◀◀] (Select +) button to get the value for "Keyboard/Playback" to flash.

```
TRANSPOSE  Link=On  
Keyboard/Playback= 0
```

7. Press the [▶/■] (Value -) button or [▶▶] (Value +) button to change the key of the song and the notes from the keyboard.

Each time you press the [▶/■] (Value -) button or [▶▶] (Value +) button, the song and the notes from the keyboard are transposed by one semitone. Pressing the [▶/■] (Value -) and [▶▶] (Value +) buttons simultaneously restores the original value (0).

The playback transposition can be set in a range from -6 to 0 to +5 (in semitone increments).

8. Press the [Function] (Exit) button so the indicator goes out.
9. Press the [▶/■] button to start playing the song.

The song is played in the changed key.

MEMO

You can transpose songs using the remote control's TRANSPOSE [-] and [+] buttons.

MEMO

When Link is set to "Off," you can transpose the song and the notes from the keyboard separately.

With Link set to "Off," the song can be transposed within the range from -24 to +24 (in semitone increments).

1. Press the [Song] (Select -) button or [◀◀] (Select +) button to get the value for "Link" to flash.
2. Press the [▶/■] (Value -) button or [▶▶] (Value +) button to switch the Link setting to "Off."
3. Press the [Song] (Select -) button or [◀◀] (Select +) button to get the value for "Playback" (Playback) to flash.
4. Press the [▶/■] (Value -) button or [▶▶] (Value +) button to change the key of the song.

■ Adding Echo to the Mic Vocals (Mic Echo)

This adjusts the microphone echo when a microphone is connected to the RG-7.

1. Press the [Function] (Exit) button so the indicator is lit.
2. Press the [Song] (Select -) button or [◀◀] (Select +) button to display the MIC ECHO screen.

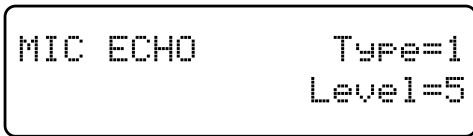

3. Press the [Song] (Select -) button or [◀◀] (Select +) button to get the value for "Type" to flash.

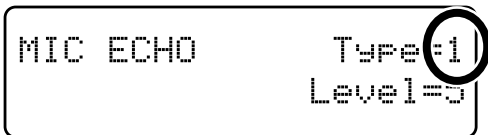

4. Press the [▶/■] (Value -) button or [▶▶] (Value +) button to change the echo type.

Value	Description
1	Adds basic reverberations.
2	Adds reverberations for a karaoke-type echo.

5. Press the [Song] (Select -) button or [◀◀] (Select +) button to get the value for "Level" to flash.

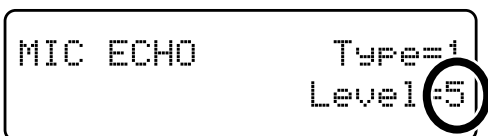

6. Press the [▶/■] (Value -) button or [▶▶] (Value +) button to change the amount of echo applied to the sound.

Value	Description
0-9	More echo is applied as the value is increased. No echo is applied to the microphone vocals when the value is set at "0."

7. Press the [Function] (Exit) button so the indicator goes out.

Chapter 1. Playing Back Songs

■ Adding Harmonies to the Mic Vocals (Harmony)

You can sing with a harmony accompaniment, even when you're playing solo. This is called the "Harmony" function.

1. Press the [Function] (Exit) button so the indicator is lit.
2. Press the [Song] (Select -) button or [◀◀] (Select +) button to display the VOCAL screen.

```
VOCAL Harmony=Off
Transformer=Off
```

3. Press the [Song] (Select -) button or [◀◀] (Select +) button to get the value for "Harmony" to flash.

```
VOCAL Harmony=Off
Transformer=Off
```

4. Press the [▶/■] (Value -) button or [▶▶] (Value +) button to change the harmony settings.

Value	Description
Unison	Sounds like two people singing the same melody.
Oct Up (Octave Up)	Adds another voice one octave higher than the original.
OctDwn (Octave Down)	Adds another voice one octave lower than the original.
5th Up	Adds harmony a fifth above the original.
3rd Up	Adds harmony a third above the original.
4thDwn (4th Down)	Adds harmony a major fourth below the original.
Data	As you sing along with the playback of the song data, harmonies consistent with the scale of the specified part are added. Set the part to which harmonies are added in "Setting the Part to Which Harmonies Are Added (Harmony Part)" (p. 95).
Off	No harmonies are added to the microphone vocals.

5. Press the [Function] (Exit) button so the indicator goes out.

NOTE

Use of the Harmony function may cause changes in the Damper Resonance effect (p. 59).

MEMO

You can change the settings for the Harmony function with the remote control's [HARMONY] button (p. 34).

NOTE

Depending on the type of harmony, there may be some songs to which harmonies cannot be added.

■ Altering Vocals (Transformer)

You can modify the way your voice sounds through the microphone. This is called the “Voice Transformer” function.

1. Press the [Function] (Exit) button so the indicator is lit.
2. Press the [Song] (Select -) button or [⏪] (Select +) button to display the VOCAL screen.

```
VOCAL Harmony=Off
Transformer=Off
```

3. Press the [Song] (Select -) button or [⏪] (Select +) button to get the value for “Transformer” to flash.

```
VOCAL Harmony=Off
Transformer=Off
```

4. Press the [▶/■] (Value -) button or [▶▶] (Value +) button to change the transformer settings.

Value	Description
Kids	Transforms the input into the sound of a child’s voice.
Bear	Transforms the input sound into the voice of a large animal.
Robot	Transforms the input into the sound of a robot’s voice.
Duck	Transforms the input into a duck’s quacking sound.
Alien	Transforms the input into an alien voice.
Computer	Transforms the input into a voice like that from a computer.
Female	Transforms male voices into female voices.
Male	Transforms female voices into male voices.
Off	The Transformer effect is not applied to the microphone vocals.

5. Press the [Function] (Exit) button so the indicator goes out.



You can change the settings for the Transformer function with the remote control’s [TRANSFORM] button (p. 34).

Copying Songs

You can copy performances recorded with the RG-7, songs saved on CD-ROMs, songs on USB memory connected to the RG-7's Ext Memory port, and other songs to the RG-7's "Favorites."

Copying songs to the "Favorites" enables you to access these songs easily by pressing the [Song] button to select the "Favorites" as the genre.

NOTE

You cannot copy songs on commercially available audio CDs or Player Piano CDs to the "Favorites."

■ Copying Songs Saved on CDs and USB Memory to the "Favorites"

1. Connect the USB memory device to the Ext Memory port or place the CD-ROM containing the song or songs you want to copy in the CD drive.
2. Press the [Function] (Exit) button so the indicator is lit.
3. Press the [Song] (Select -) button or [◀◀] (Select +) button to display the FILE screen.



```
FILE
SAVE COPY DEL FORMAT
```

4. Press the [Song] (Select -) button or [◀◀] (Select +) button so "COPY" is flashing.



```
FILE
SAVE (COPY) DEL FORMAT
```

5. Press the [Moving Key] (Enter) button.
6. Press the [Song] (Select -) button or [◀◀] (Select +) button so that the "COPY From" setting is flashing.



```
COPY From (Ext Memory)
1: Love me Tender
```

- 7** Press the [▶/■] (Value -) button or [▶▶] (Value +) button to change the “COPY From” setting.

Value	Description
Jazz	Internal songs in the “Jazz” genre are copied to the “Favorites.”
Classical	Internal songs in the “Classical” genre are copied to the “Favorites.”
CD	Songs in the CD-ROM are copied to the USB memory or the “Favorites.”
Ext Memory	Songs in the USB memory device are copied to the “Favorites.”
Favorites	Songs in the “Favorites” are copied to the USB memory device.

- 8.** Press the [Song] (Select -) button or [◀◀] (Select +) button so that the “COPY From” song number is flashing.



- 9.** Press the [▶/■] (Value -) button or [▶▶] (Value +) button to select the number of the song you want to copy.

- 10** Press the [Moving Key] (Enter) button.

To copy songs on a CD, continue the procedure from Step 11.

To copy songs stored in USB memory and internal songs, carry out Step 10, then continue the procedure from Step 14.

- 11.** When selecting “CD” as the copy source, press the [Song] (Select -) button or [◀◀] (Select +) button so that the “COPY To” setting is flashing.

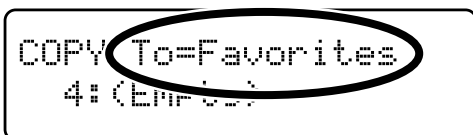

- 12.** Press the [▶/■] (Value -) button or [▶▶] (Value +) button to select the copy destination.

Value	Description
Favorites	Copies the song to the “Favorites.”
Ext Memory	Copies the song to the USB memory.

Chapter 1. Playing Back Songs

- 13** Press the [Song] (Select -) button or [I◀◀] (Select +) button so that the “COPY To” song number is flashing.

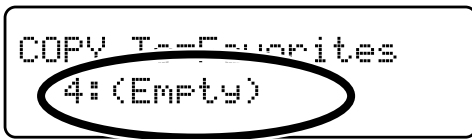

- 14** Press the [▶/■] (Value -) button or [▶▶] (Value +) button to select the copy-destination number.

- 15** Press the [Moving Key] (Enter) button.

The song is copied.

- 16.** Press the [Function] (Exit) button so the indicator goes out.

When there is no song assigned to a number, this is indicated in the display in the following form: “4: (Empty).”

A screenshot of a monochrome LCD display. The top line shows the text "COPY To=Favorites". The second line shows "4:(Empty)".

If you select a number to which a song is already saved and then attempt to copy to that number, the following message appears in the display.

A screenshot of a monochrome LCD display. The top line shows the text "COPY Overwrite sure?". The second line shows "3:Yellow Submarine".

To delete the saved song and copy the new song to that number, press the [Moving Key] (Enter) button. If you do not want to delete the saved song, press the [Function] (Exit) button.

NOTE

When copying performances saved to USB memory, do not remove the USB memory device until copying is finished.

Deleting Songs Saved to the “Favorites” or USB Memory

This deletes songs saved to USB Memory (sold separately) and the “Favorites.”

If deleting songs saved to USB Memory, connect the USB memory device to the Ext Memory port.

1. Press the [Function] (Exit) button so the indicator is lit.
2. Press the [Song] (Select -) button or [I◀◀] (Select +) button to display the FILE screen.



```
FILE
SAVE| COPY| DEL| FORMAT
```

3. Press the [Song] (Select -) button or [I◀◀] (Select +) button so “DEL” (Delete) is flashing.



```
FILE
SAVE| COPY| (DEL)| FORMAT
```

4. Press the [Moving Key] (Enter) button.
The following screen appears.



```
DELETE      Favorites
1:Love me tender
```

5. Press the [Song] (Select -) button or [I◀◀] (Select +) button so that the “Saved Song to Delete” setting is flashing.



```
DELETE      (Favorites)
1:Love me tender
```

Chapter 1. Playing Back Songs

- 6.** Press the [▶/■] (Value -) button or [▶▶] (Value +) button to select “Saved Song to Delete.”

Value	Description
Favorites	Deletes the songs in the “Favorites.”
Ext Memory	Deletes the songs in the USB memory.

- 7.** Press the [Song] (Select -) button or [◀◀] (Select +) button to get the “song number” to flash.



- 8.** Press the [▶/■] (Value -) button or [▶▶] (Value +) button to select the song to be deleted.

- 9** Press the [Moving Key] (Enter) button.

A confirmation message appears in the screen.

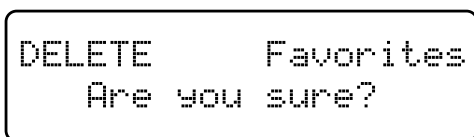

To return to the original screen without deleting the song, press the [Function] (Exit) button.

- 10** Press the [Moving Key] (Enter) button once more.

The song is deleted.

- 11.** Press the [Function] (Exit) button so the indicator goes out.

NOTE

When deleting performances saved to USB memory, do not remove the USB memory device until deleting is finished.

Chapter 2. Using the RG-7 with an External Display or Television

You can connect a computer monitor or other external display or a television to the RG-7, enabling you to display the Song Select screen, your favorite images, song lyrics, and notations on a larger screen.

You cannot simultaneously use both an external display and a television with the RG-7. Moreover, neither the external display nor the television will be able to display properly if both are connected at the same time.

When using an external display, connect the display to the Ext Display connector, but do not connect a television to the Video Out connector.

If using a television, connect the television to the Video Out connector, but do not connect any external display to the Ext Display connector.

For more information about external display settings, refer to "Selecting What is To Be Displayed on the External Display or Television" (p. 50).

MEMO

You can switch screens with the remote control. For details, see "About the Remote Control" (p. 34).

Connecting an External Display

Displays That Can Be Connected to This Instrument

In general, a great many of the VGA monitors and multiscan monitors that are available on the market are compatible with this instrument. However, before you connect any monitor, make sure it meets the following specifications:

Resolution	640 x 480 pixels
Horizontal scan frequency	31.5 kHz
Vertical scan frequency	60 Hz
Connector	3-row, 15-pin D-Sub type
Signal	Analog

■ Making the Connections

* To prevent malfunction and/or damage to speakers or other devices, always turn down the volume, and turn off the power on all devices before making any connections.

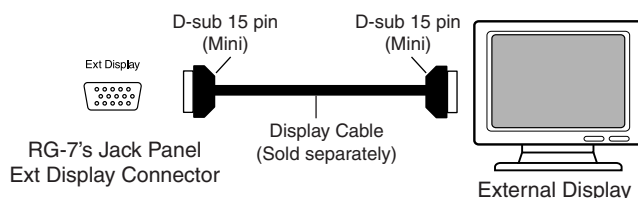

1 Turn off the power to the RG-7 and the display to be connected.

2 Use display cable (sold separately) to connect the display to the Ext Display connector on the RG-7.

NOTE

Confirm that your display is compatible with the frequencies listed to the left. Using a display that is not compatible with the left frequencies may result in incorrect image output when images move, and in certain cases may even damage the display.

NOTE

You cannot display information or images with an external display when a television is connected to the Video Out jack. To use an external display, first disconnect the television from the Video Out jack, then connect the external display.

Chapter 2. Using the RG-7 with an External Display or Television

3 Switch on the RG-7.

4 Switch on the connected display.

Turning the Power Off

After use, turn off the power using the following procedure.

1 Turn the volume all the way down on the RG-7.

2 Turn off the RG-7.

3 Turn off the connected display.

■ Changing the Display Settings

1. Press the [Function] (Exit) button so the indicator is lit.

2. Press the [Song] (Select -) button or [◀◀] (Select +) button to display the EXT DISPLAY screen.



```
EXT DISPLAY      UGA
Slide Interval= 2sec
```

3. Press the [Song] (Select -) button or [◀◀] (Select +) button so that the display setting is flashing.



```
EXT DISPLAY      UGA
Slide Interval= 2sec
```

4. Press the [▶/■] (Value -) button or [▶▶] (Value +) button to select "VGA."

5. Press the [Function] (Exit) button so the indicator goes out.

Images are now displayed in the screen of the connected external display.

When you press the [DISPLAY] button on the remote control, the content being displayed switches to the external display.

To change the settings indicated in the display (Song Select screen → Lyrics screen → Slide show → Notation → Song Select screen...), refer to "Selecting What is To Be Displayed on the External Display or Television" (p. 50).



For more on handling the external display, refer to your display's owner's manual.



You can save this setting in the RG-7's memory using the Memory Backup function (p. 72).

Connecting a Television

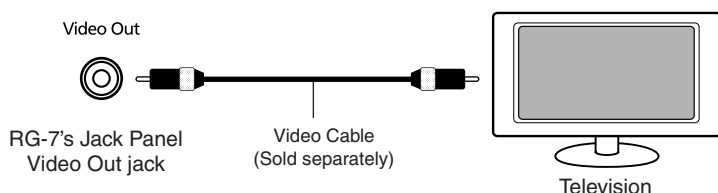

NOTE

You cannot display information or images with a television when an external display is connected to the Ext Display connector. To use a television, first disconnect the external display from the Ext Display connector, then connect the television.

■ Making the Connections

* To prevent malfunction and/or damage to speakers or other devices, always turn down the volume, and turn off the power on all devices before making any connections.

- 1 Turn off the power to the RG-7 and the television to be connected.
- 2 Use a video cable (sold separately) to connect the RG-7's Video Out jack with the television's video input jack.
- 3 Turn on the power to the RG-7.
- 4 Turn on the power to the television.

■ Switching Television Formats

If you find that the image quality of the television is poor, try switching the television format.

1. Press the [Function] (Exit) button so the indicator is lit.
- 2 Press the [Song] (Select -) button or [◀◀] (Select +) button to display the EXT DISPLAY screen.
3. Press the [▶/■] (Value -) button or [▶▶] (Value +) button to select the television format.

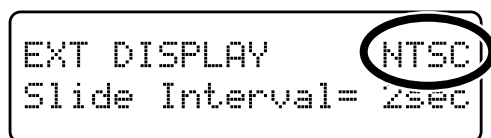

Value: PAL, NTSC

4. Press the [Function] (Exit) button so the indicator goes out.

When you press the [DISPLAY] button on the remote control, the content being displayed switches to the television.

To change the settings indicated in the display (Song Select screen → Lyrics screen → Slide show → Notation → Song Select screen...), refer to "Selecting What is To Be Displayed on the External Display or Television" (p. 50).

MEMO

You can save this setting in the RG-7's memory using the Memory Backup function (p. 72).

Selecting What is To Be Displayed on the External Display or Television

Here's how you can specify what it is that you want to have displayed on the external display or television connected to the RG-7.

1. Press the remote control's [DISPLAY] button to switch the content displayed in the external display or television.

Screen Displayed	Description
Song Select	Displays the Song Select screen. Selecting songs is made easier when the Song Select screen is displayed on an external display or television set.
Lyrics	Displays the Song Select screen. However, lyrics are displayed only during playback of music data that includes lyrics data. You can also connect USB memory to the Ext Memory port and display "karaoke background images" saved to the USB memory. For more details, refer to "Changing the Background for the Lyrics Screen" (p. 52).
Slide Show	You can connect USB memory to the Ext Memory port and display user images saved to the USB memory as slide shows. For more details, refer to "Displaying Favorite Images on an External Display or Television (Slide Show)" (p. 51).
Notation	Displays the notation. This allows you to check the music as the song is played back.

2. Press the [Function] (Exit) button so the indicator goes out.

Notes When Switching the Display on External Displays and Televisions

- Lyrics are not displayed with audio CDs.
- You cannot exhibit slide shows on an external display or television screen unless you connect USB memory containing user images to the Ext Memory port.
- If no lyrics background image is stored in the USB memory connected to the Ext Memory port, the RG-7's internal lyrics background image is displayed instead.
- You cannot display any lyrics screen when playing back music data that does not include lyrics data.
- The internal songs include a number of jazz pieces that are played in an improvised fashion, and you may find notes not conforming to measure lines, odd divisions of the parts played in the left and right hand, and other such features that do not match what is shown in the notation.

Displaying Favorite Images on an External Display or Television (Slide Show)

With the RG-7, you can take desired image data saved in USB memory and display it on a connected external display or television set.

First, you will need to have saved the image data and connected the USB memory to the Ext Memory port.

Preparing the Images to be Displayed

Prepare the desired image data on your computer and save the data to the USB memory.

1. Prepare the desired image data with your computer.

Image Data That Can Be Displayed	
Size	640 x 480 pixels
Color	8 bit (256 colors), 4 bit (16 colors), 1 bit (2 colors)
Format	BMP Format * The RG-7 cannot deal with compressed image data.
Name	SCENE***.BMP ***: 001-099

2. Connect the USB memory to your computer, then create a folder named “_PICTURE” in the USB memory.
3. Place the images you want to display in the “_PICTURE” folder.

Setting the Duration for Displaying Images

When you have data for multiple images saved to the USB memory and want to display these images on a connected display or television set, you can specify the length of time each image appears.

1. Press the [Function] (Exit) button so the indicator is lit.
2. Press the [Song] (Select -) button or [◀◀] (Select +) button to display the EXT DISPLAY screen.
3. Press the [Song] (Select -) button or [◀◀] (Select +) button to get the value for “Slide Interval” to flash.



4. Press the [▶/■] (Value -) button or [▶▶] (Value +) button to set the time a single image is to be displayed.
Value; 2-60 seconds
5. Press the [Function] (Exit) button so the indicator goes out.



The folder named “_PICTURE” is not shown in the Song Select screen.



You can save this setting in the RG-7's memory using the Memory Backup function (p. 72).

Chapter 2. Using the RG-7 with an External Display or Television

Running Slide Shows Through a Connected External Display or Television

- 1.** Make sure the power to the RG-7 is turned off, then connect the external display or television (p. 47, p. 49).
- 2** Turn on the power to the RG-7 and the external display (or television).
- 3** Make the settings for the display or television format (p. 48, p. 49).
- 4** Connect the USB memory containing the saved images you want to display to the Ext Memory port.
- 5** Pressing the remote control's [DISPLAY] button, make the settings for the slide show to appear in the external display or television.
The slide show appears in the external display or television screen.

Changing the Background for the Lyrics Screen

You can have the background you prefer shown when displaying lyrics on an external display or television screen.

Preparing the Images to be Displayed

Prepare the desired image data on your computer and save the data to the USB memory.

- 1.** Prepare the desired image data with your computer.

Image Data That Can Be Displayed	
Size	640 x 480 pixels
Color	8 bit (256 colors), 4 bit (16 colors), 1 bit (2 colors)
Format	BMP Format * The RG-7 cannot deal with compressed image data.
Name	KARAOKE.BMP

- 2** Connect the USB memory to your computer, then create a folder named "_PICTURE" in the USB memory.
- 3** Copy the image data you have created (KARAOKE.BMP) to the "_PICTURE" folder.
- 4** Make sure the power to the RG-7 is turned off, then connect the external display or television (p. 47, p. 49).
- 5** Turn on the power to the RG-7 and the external display (or television).
- 6** Connect the USB memory containing the saved image you want to display (KARAOKE.BMP) to the Ext Memory port.
- 7** Pressing the remote control's [DISPLAY] button, set the external display or television to display the lyrics.
The desired background image is shown in the external display or television screen.

NOTE

You cannot display any lyrics screen when playing back music data that does not include lyrics data.

Chapter 3. Performance

Performing with a Variety of Sounds

The RG-7 contains 20 different internal tones. The tones are organized into five tone groups, which are assigned to the Tone buttons.

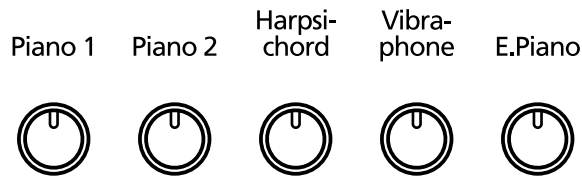

Selecting a Tone Group

- 1 Press any Tone button.

The indicator of the button you pressed will light.

When you play the keyboard, you will hear a sound in the selected tone group.

Selecting Variation Tones

- 2 While holding down the Tone button and the [▶/■] (Value -) or [▶▶] (Value +) button to select the tone.

The tone name appears in the display.

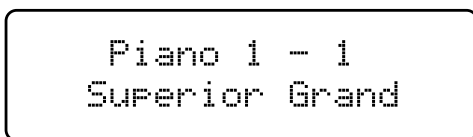

The tone you've selected is heard when you finger the keyboard.

Piano 1		Piano 2		Harpsichord	
1	Superior Grand	1	Natural Grand	1	Harpsichord
2	Superior Grand + Str	2	Natural Grand + Str	2	Coupled Harpsichord
3	Superior Grand + Pad	3	Natural Grand + Pad	3	Harpsichord + Choir
4	Piano + FM E.Piano	4	Piano + Bell	4	Harpsichord + Str

Vibraphone		E.Piano	
1	Vibraphone	1	Electric Piano
2	Bell	2	FM E.Piano
3	Harp	3	'60s Electric Piano
4	Electric Piano + Pad	4	Electric Piano + Str

Some tones are assigned a pair of tones, which allow you to perform with two tones layered together.

MEMO

The factory settings have tone demos registered in the "Favorites" (p. 25). You can check and confirm the internal tones.

You can delete tone demos in the "Favorites" and overwrite them by saving other songs in their place. If you want to play back tone demos after they have been deleted, initialize the User Memory to restore the factory settings (p. 92).

MEMO

You can also switch the Split function (p. 66) on and off by holding down a tone button and pressing the [Song] button. The Tone screen appears as shown below when the Split function is on.

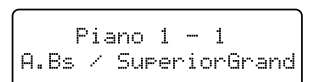

Pressing a tone button once more cancels the Split function.

■ Changing the Volume Balance of the Layered Tones (Layer Balance)

Some tones enable you to perform with two tones layered together. These are called “Layer tones.”

When you select a Layer tone, you can also change the balance in the volume of the two Layer tones.

- 1 Press the [Function] (Exit) button so the indicator is lit.
- 2 Press the [Song] (Select -) button or [◀◀] (Select +) button to display the BALANCE screen.



```
BALANCE Key:Acmp=5:5
Layer=7:3
```

- 3 Press the [Song] (Select -) button or [◀◀] (Select +) button to get the value for “Layer” to flash.



```
BALANCE Key:Acmp=5:5
Layer=7:3
```

- 4 Press the [▶/■] (Value -) button or [▶▶] (Value +) button to adjust the volume balance.

Value: 1:9-9:1

The volume increases as the value is raised.

The numeral on the left indicates the tone’s original volume level, and the number on the right indicates the volume of the tone as played with the other Layer tone.

Example: When Natural Grand+Str (Natural Grand Piano + Strings) are selected as the tones



```
BALANCE Key:Acmp=5:5
Layer=7:3
```

Volume level of Strings

Volume level of Natural Grand (Natural Grand Piano)

- 5 Press the [Function] (Exit) button so the indicator goes out.

Making Fine Adjustments to the Piano Sound

You can make fine adjustments to the sound of the piano as desired.

■ Adjusting the Keyboard Touch (Key Touch)

You can adjust the touch (playing feel) of the keyboard.

- 1 Press the [Function] (Exit) button so the indicator is lit.
2. Press the [Song] (Select -) button or [◀◀] (Select +) button to display the KEY TOUCH screen.



KEY TOUCH Touch= 65
Hammer=Light

3. Press the [Song] (Select -) button or [◀◀] (Select +) button to get the value for “Touch” to flash.



KEY TOUCH Touch= 65
Hammer=Light

- 4 Press the [▶/■] (Value -) button or [▶▶] (Value +) button to change the value.

Indicator	Settings
1-100	The keyboard touch gets lighter as the value decreases, with the touch becoming heavier as the value is increased.
Fix	The sound plays at a fixed volume, regardless of how forcefully the keys are played.

5. Press the [Function] (Exit) button so the indicator goes out.

Fortissimo (ff) can be played with a lighter touch as the value is decreased, making it feel like the keyboard has a lighter touch. This setting makes it easy to play, even for children.

Increasing the value gives the instrument a heavier key touch. Fortissimo (ff) cannot be produced unless you play more strongly than usual, making the keyboard feel heavier. Dynamic fingering adds even more feeling to what you play.

A value of around 65 provides a standard setting, producing the most natural touch. This is the closest to the touch of an acoustic piano.



You can save this setting in the RG-7's memory using the Memory Backup function (p. 72).

■ Changing the Timing of Sounds According to the Force Used to Press the Keys (Hammer Response)

This adjusts how your playing strength will affect the timing at which the note sounds. This is called the “Hammer Response” function.

On an acoustic piano, pressing a key moves a hammer, which strikes a string to produce sound. If you press the key softly, the hammer will move slowly, meaning that it will take slightly longer (in comparison to a strongly-played note) from the moment you press the key until the sound is produced.

If the Hammer Response function is turned on, the time between the moment you press a key until the sound is heard will change depending on the strength with which you play. As you play more softly, this time will become longer.



You can save this setting in the RG-7's memory using the Memory Backup function (p. 72).

1 Press the [Function] (Exit) button, getting its indicator to light.

2 Press the [Song] (Select -) button or [I◀◀] (Select +) button to display the KEY TOUCH screen.

```
KEY TOUCH  Touch= 65
           Hammer=Light
```

3 Press the [Song] (Select -) button or [I◀◀] (Select +) button to get the value for “Hammer” to flash.

```
KEY TOUCH  Touch= 65
           Hammer=Light
```

4 Press the [▶/■] (Value -) or [▶▶] (Value +) button to change the value.

Value	Description
Light	The response is faster when the keys are pressed gently.
Medium	The regular timing is used when the keys are pressed gently.
Heavy	The timing of the sounds is delayed when the keys are pressed gently.
Off	The Hammer Response function is cancelled. The sound is played immediately, regardless of the force with which the keys are played (velocity).

5 Press the [Function] (Exit) button so the indicator goes out.

■ Playing Sounds When the Keys Are Released (Key Off Resonance)

You can play the “key off” sound (the subtle sound produced when the keys are released) obtained when playing an acoustic piano.

- 1** Press the [Function] (Exit) button, getting its indicator to light.
- 2** Press the [Song] (Select -) button or [◀◀] (Select +) button to display the RESONANCE screen.

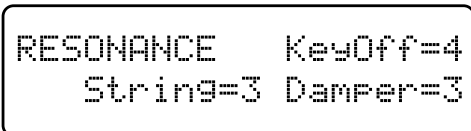

- 3** Press the [Song] (Select -) button or [◀◀] (Select +) button to get the value for “KeyOff” to flash.

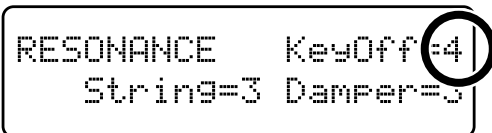

- 4** Press the [▶/■] (Value -) or [▶▶] (Value +) button to change the value.

Value	Description
0-9	The volume of the Key Off sound decreases as the value is lowered, while raising the value increases the volume of the Key Off sound. The Key Off Resonance function is not active when the value is set to “0.”

- 5** Press the [Function] (Exit) button so the indicator goes out.



This setting is enabled only with the piano tones (Superior Grand, Natural Grand) and harpsichord tones (Harpsichord, Coupled Harpsichord). You cannot set this for other tones.



You can save this setting in the RG-7's memory using the Memory Backup function (p. 72).

■ Producing the Resonance of the Strings When the Keys Are Played (String Resonance)

When you play the keys on an acoustic piano, the strings that are already playing resonate as well. The function that reproduces this effect is called “String Resonance.”

1 Press the [Function] (Exit) button, getting its indicator to light.

2 Press the [Song] (Select -) button or [◀◀] (Select +) button to display the RESONANCE screen.

```

RESONANCE  KeyOff=4
           String=3  Damper=3
    
```

3 Press the [Song] (Select -) button or [◀◀] (Select +) button to get the value for “String” to flash.

```

RESONANCE  KeyOff=4
           String=3  Damper=3
    
```

4 Press the [▶/■] (Value -) or [▶▶] (Value +) button to change the value.

Value	Description
0-9	The resonance level decreases as the value is decreased, while increasing the value increases the amount of resonance. The String Resonance function is not active when the value is set to “0.”

5 Press the [Function] (Exit) button so the indicator goes out.

NOTE

This setting is enabled only with the piano tones. You cannot set this for other tones.

MEMO

You can save this setting in the RG-7's memory using the Memory Backup function (p. 72).

■ Producing the Resonance of the Strings When the Keys Are Played (Damper Resonance)

You can change the volume of the damper pedal resonance.

On an acoustic piano, depressing the damper pedal makes the notes you play resonate with other strings, adding rich reverberations and fatness to the sound. The damper pedal on the RG-7 recreates this resonance (Damper Resonance) when depressed.

1 Press the [Function] (Exit) button, getting its indicator to light.

2 Press the [Song] (Select -) button or [I◀◀] (Select +) button to display the RESONANCE screen.

```
RESONANCE  KeyOff=4
           String=3 Damper=3
```

3 Press the [Song] (Select -) button or [I◀◀] (Select +) button to get the value for “Damper” to flash.

```
RESONANCE  KeyOff=4
           String=3 Damper=3
```

4 Press the [▶/■] (Value -) or [▶▶] (Value +) button to change the value.

Value	Description
0-9	The resonance volume decreases as the value is lowered, while raising the value increases the volume of the Damper Resonance. The Damper Resonance function is not active when the value is set to “0.”

5 Press the [Function] (Exit) button so the indicator goes out.

NOTE

This setting is enabled only with the piano tones. You cannot set this for other tones.

MEMO

You can save this setting in the RG-7's memory using the Memory Backup function (p. 72).

■ Adjusting the Sound to Achieve the Preferred Tone Quality (Equalizer)

The RG-7 features a built-in, three-band digital equalizer.

An equalizer boosts or cuts specific sound pitches (frequency ranges) to adjust the sound balance for the overall performance. For example, you can boost the highs to get a crisper sound, or boost the low end for a more powerful sound.

You can also adjust the sound to compensate for the acoustical characteristics of the performance space.

If raising the values for separate frequencies causes the sound to distort, you can use the “Master Level” (see below) to control such distortion.

1 Press the [Function] (Exit) button, getting its indicator to light.

2 Press the [Song] (Select -) button or [◀◀] (Select +) button to display the EQUALIZER screen.

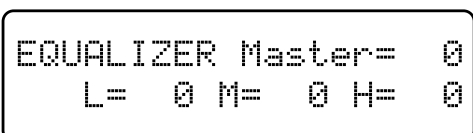

3 Press the [Song] (Select -) button or [◀◀] (Select +) button so that the value for the range you want to set is flashing.



Value	Description
Master (Master Level)	You can temper the distortion in the sound by lowering the level. Raising the level too much may cause the sound to become distorted.
L (Low)	Low-frequency range. This is the range of frequencies for instruments like drums, bass, organ, guitar and strings.
M (Middle)	Midrange. This is the range of frequencies where most instrument sounds are concentrated.
H (High)	High-frequency range. These frequencies add brilliance to the sound.

4 Press the [▶/■] (Value -) button or [▶▶] (Value +) button to adjust the range and the overall level.

Value: -60 – 0 – +60

5 Press the [Function] (Exit) button so the indicator goes out.



You can save this setting in the RG-7's memory using the Memory Backup function (p. 72).

Changing the Pitch of the Keyboard Sound (Transpose)

By using the “Transpose function,” you can transpose your performance without changing the notes you play. For example, even if the song is in a difficult key with numerous sharps (♯) or flats (♭), you can transpose it to a key that is easier for you to play. When accompanying a vocalist, you can easily transpose the pitch to a range that is comfortable for the singer, while still playing the notes as written (i.e., with the same fingering positions).

1. Press the [Function] (Exit) button so the indicator is lit.
2. Press the [Song] (Select -) button or [⏪] (Select +) button to display the TRANSPOSE screen.



```
TRANSPOSE  Link=On
Keyboard/Playback= 0
```

3. Press the [Song] (Select -) button or [⏪] (Select +) button to get the value for “Link” to flash.



```
TRANSPOSE  Link=On
Keyboard/Playback= 0
```

4. Press the [▶/■] (Value -) button or [▶▶] (Value +) button to switch the Link setting to “On.”
5. Press the [Song] (Select -) button or [⏪] (Select +) button to get the value for “Keyboard/Playback” to flash.



```
TRANSPOSE  Link=On
Keyboard/Playback= 0
```

6. Press the [▶/■] (Value -) button or [▶▶] (Value +) button to select the transposition value.

The keyboard is transposed by a semitone each time you press the [▶/■] (Value -) button or [▶▶] (Value +) button. Pressing the [▶/■] (Value -) and [▶▶] (Value +) buttons simultaneously returns the setting to the original value (0).

This can be set in a range of -6–0–+5 (semitone steps).

MEMO

When Link is set to “Off,” you can transpose the song and the notes from the keyboard separately.

Example: Playing a song in E major while playing the keys for C major

In this example, C is the root note in the key of C major. E, the root of E major, is the third in C major. It is up four keys, including the black keys, so touch, then enter "4" for the setting.

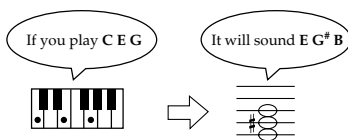

Canceling the Transpose Function

- 1 Press the [▶/■] (Value -) and [▶▶] (Value +) buttons simultaneously to select "0."

Tuning to Other Instruments' Pitches (Master Tuning)

In situations such as when playing ensemble with other instruments, you can tune the RG-7's standard pitch to the pitch of another instrument. The standard pitch generally refers to the pitch of the note that's played when you finger the middle A key. This tuning of all the instruments to a standard pitch is called "tuning."

- 1 Press the [Function] (Exit) button, getting its indicator to light.
- 2 Press the [Song] (Select -) button or [◀◀] (Select +) button to display the TUNE screen.

```
TUNE 440.0 Stretch=2
Equal          Key=C
```

- 3 Press the [Song] (Select -) button or [◀◀] (Select +) button to get the value for the Master Tuning setting to flash.

```
TUNE 440.0 Stretch=2
Equal          Key=C
```

- 4 Press the [▶/■] (Value -) button or [▶▶] (Value +) button to change the standard pitch.

Value 415.3 Hz–440.0 Hz–466.2 Hz

This is set to "440.0" when the power to the RG-7 is switched on.

- 5 Press the [Function] (Exit) button so the indicator goes out.



You can save this setting in the RG-7's memory using the Memory Backup function (p. 72).

Setting the Tuning Curve (Stretch Tuning)

Pianos are generally tuned so that the low range is flatter and the high range is sharper than equal tempered pitches. This method of tuning is unique to the piano, and is known as “stretched tuning.”

A graph that shows the changes in pitch of actual tuning compared with the changes in equal temperament pitch is called a tuning curve. Changing the tuning curve produces subtle variations in the reverberations of the chords you play.



You can save this setting in the RG-7's memory using the Memory Backup function (p. 72).

1 Press the [Function] (Exit) button, getting its indicator to light.

2 Press the [Song] (Select -) button or [◀◀] (Select +) button to display the TUNE screen.

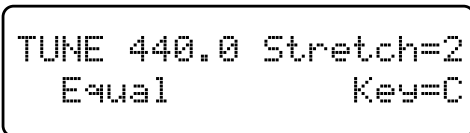

3 Press the [Song] (Select -) button or [◀◀] (Select +) button to get the value for “Stretch” to flash.

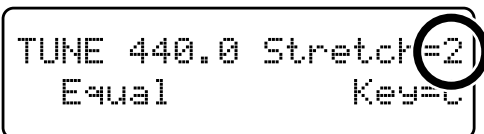

4 Press the [▶/■] (Value -) button or [▶▶] (Value +) button to change the Stretch Tuning setting.

Value	Description
1	This is the standard tuning curve. It is suitable when playing in an ensemble with other instruments.
2	This tuning curve expands the bass and treble ends somewhat. It is suitable for performances such as piano solos.

This is set to “2” when the power to the RG-7 is switched on.

5 Press the [Function] (Exit) button so the indicator goes out.

Changing the Tuning

You can play classical styles such as Baroque using historic temperaments (tuning methods).

Most modern songs are composed for and played in equal temperament, the most common tuning in use today. But at one time, there were a wide variety of other tuning systems in existence. By playing in the temperament that was in use when a composition was created, you can experience the sonorities of chords originally intended for that song.

- 1** Press the [Function] (Exit) button, getting its indicator to light.
- 2** Press the [Song] (Select -) button or [I◀◀] (Select +) button to display the TUNE screen.



TUNE 440.0 Stretch=2
Equal Key=C

- 3** Press the [Song] (Select -) button or [I◀◀] (Select +) button to get the Temperament setting to flash.

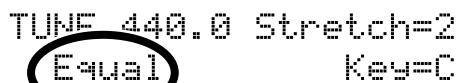

TUNE 440.0 Stretch=2
Equal Key=C

- 4** Press the [▶/■] (Value -) button or [▶▶] (Value +) button to select the temperament.

Display	Qualities
Equal	In this tuning, each octave is divided into twelve equal steps. Every interval produces about the same amount of slight dissonance.
Just(Maj)	This tuning eliminates ambiguities in the fifths and thirds. It is unsuited to playing melodies and cannot be transposed, but is capable of beautiful sonorities.
Just(min)	The Just tunings differ from major and minor keys. You can get the same effect with the minor scale as with the major scale.
Kirnberger	This is an improvement of the Mean Tone and Just tunings that provides a high degree of freedom of modulation. Performances are possible in all keys (III).
Pythagorean	This tuning, devised by the philosopher Pythagoras, eliminates dissonance in fourths and fifths. Dissonance is produced by third-interval chords, but melodies are euphonious.
Mean Tone	This scale makes some compromises in just intonation, enabling transposition to other keys.



You can save this setting in the RG-7's memory using the Memory Backup function (p. 72).

Display	Qualities
Werckmeister	This temperament combines the Mean Tone and Pythagorean tunings. Performances are possible in all keys (first technique, III).
Arabic	This tuning is suitable for the music of Arabia.

When playing with tuning other than equal temperament, you need to specify the tonic note for tuning the song to be performed (that is, the note that corresponds to C for a major key or to A for a minor key).

5 Press the [Function] (Exit) button so the indicator goes out.

■ Setting the Tonic

When playing with tuning other than equal temperament, you need to specify the tonic note for tuning the song to be performed (that is, the note that corresponds to C for a major key or to A for a minor key).

If you choose an equal temperament, there's no need to select a tonic note.

1 Press the [Function] (Exit) button, getting its indicator to light.

2 Press the [Song] (Select -) button or [I◀◀] (Select +) button to display the TUNE screen.

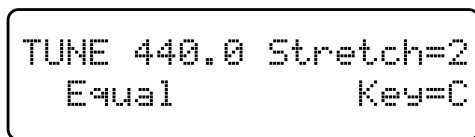

3 Press the [Song] (Select -) button or [I◀◀] (Select +) button to get the value for "Key" to flash.

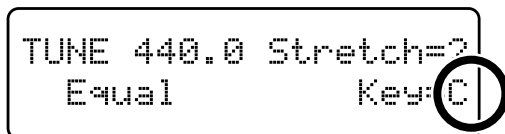

4 Press the [▶/■] (Value -) button or [▶▶I] (Value +) button to select the tonic.

Display	C	C#	D	Eb	E	F	F#	G	Ab	A	Bb	B
Letter name	C	C#	D	E _b	E	F	F#	G	A _b	A	B _b	B

5 Press the [Function] (Exit) button so the indicator goes out.

NOTE

When performing in ensemble with other instruments, be aware that depending on the key, there may be some shifting of the pitch. Tune the RG-7 to the fundamental pitch of the other instruments.

MEMO

You can save this setting in the RG-7's memory using the Memory Backup function (p. 72).

Playing Different Tones with the Left and Right Hands (Split Performance)

Dividing the keyboard into right-hand and left-hand areas, then playing different sounds in each is called “Split performance.” The boundary key is called the “split point.”

The split point key is included in the left-hand keyboard area. Each time power to the keyboard is turned on, the split point is reset to “F#3.”

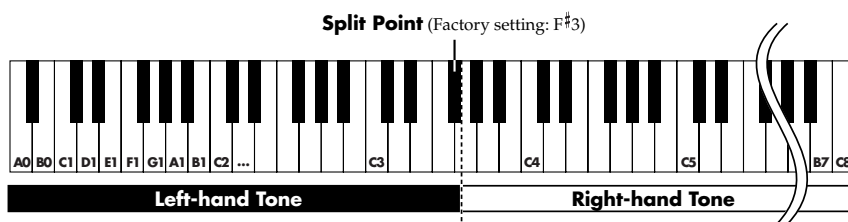

- 1 Select a tone (p. 53).
- 2 Press the [Function] (Exit) button, getting its indicator to light.
- 3 Press the [Song] (Select -) button or [◀◀] (Select +) button to display the SPLIT screen.

```
SPLIT      SPlit=Off
          SPlit Point=F#3
```

- 4 Press the [Song] (Select -) button or [◀◀] (Select +) button to get the value for “Split” to flash.

```
SPLIT      SPlit=Off
          SPlit Point=F#3
```

- 5 Press the [▶/■] (Value -) or [▶▶] (Value +) button to select “On.”

The keyboard is divided into right-hand and left-hand areas.

The tone played prior to Split Play is selected for the right hand, and a suitable tone to match that tone is selected for the left hand automatically.

- 6 To exit Split mode, press the [▶/■] (Value -) button or [▶▶] (Value +) button to set the “Split” setting to “Off.”

MEMO

You can change the split point; refer to “Changing the Keyboard’s Split Point” (p. 67).

MEMO

You can switch Split mode on and off by holding down the tone button and pressing the [Song] button.

The Tone screen appears as shown below when the Split function is on.

```
Piano 1 - 1
A.Bs / SuperiorGrand
```

Pressing a tone button once more cancels the Split function.

For more about the tones with which this setting is enabled, refer to the “Tone List” (p. 107).

■ Changing the Keyboard's Split Point

You can change the location where the keyboard is divided (the split point).

- 1** Press the [Function] (Exit) button, getting its indicator to light.
- 2** Press the [Song] (Select -) button or [◀◀] (Select +) button to display the SPLIT screen.

```
SPLIT      Split=On
          Split Point=F#3
```

- 3** Press the [Song] (Select -) button or [◀◀] (Select +) button to get the value for "Split Point" to flash.

```
SPLIT      Split=On
          Split Point=F#3
```

- 4** Press the [▶/■] (Value -) or [▶▶] (Value +) button to select the split point.

You can set the split point within a range of B1 to B6.

This is set to "F#3" when the power to the RG-7 is switched on.

- 5** Press the [Function] (Exit) button so the indicator goes out.

Adding Reverberation to the Sound (Reverb)

Apply a reverb effect to the notes you play with the RG-7.

Reverb makes it sound as if you are playing in a concert hall.

1. Press the [Function] (Exit) button so the indicator is lit.
2. Press the [Song] (Select -) button or [I◀◀] (Select +) button to display the EFFECT screen.

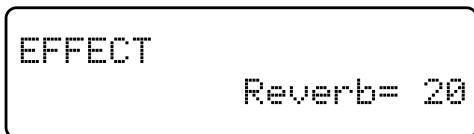

3. Press the [Song] (Select -) button or [I◀◀] (Select +) button to get the value for "Reverb" to flash.

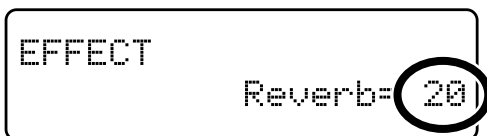

4. Press the [▶/■] (Value -) button or [▶▶] (Value +) button to change the amount of reverb applied.

Value	Description
0-127	Increasing the value results in a deeper reverb effect. No reverb is applied when the value is set to "0."

5. Press the [Function] (Exit) button so the indicator goes out.



You can save this setting in the RG-7's memory using the Memory Backup function (p. 72).

Assigning Functions to Pedals

You can assign a variety of functions to the left and center pedals.

You can call up the assigned functions just by pressing the corresponding pedal.

1. Press the [Function] (Exit) button so the indicator is lit.
2. Press the [Song] (Select -) button or [I◀◀] (Select +) button to display the PEDAL screen.

```
PEDAL Cent=Sostenuto
      Left=Soft
```

3. Press the [Song] (Select -) button or [I◀◀] (Select +) button to get the value for "Cent" (Center Pedal) or "Left" (Left Pedal) to flash.

```
PEDAL Cent=Sostenuto
      Left=Soft
```

4. Press the [▶/■] (Value -) button or [▶▶I] (Value +) button to select the function assigned to the pedal.

Value	Description
Sostenuto	The pedal functions as a sostenuto pedal (p. 20).
Soft	The pedal functions as a soft pedal (p. 20).
Play/Stop	Starts and stops playback of the song.
LwrDamper (Lower Damper)	Applies a damper pedal effect to the sounds in the left-hand side of the keyboard.

Chapter 3. Performance

Value	Description
Pedal EX	<p>If you have a Layer tone (p. 54) selected, the original tone is played whenever the pedal is not being pressed as you perform. When you perform while pressing the pedal, an layer tone is played together with the original tone. The volume of the layer tone is adjusted according to how much you press the pedal.</p> <p>Example: When “Harpichord + Choir” are selected</p> <ul style="list-style-type: none">• Playing the keyboard without pressing the pedal Only the harpsichord tone is played.• Playing the keyboard while pressing the pedal When the pedal is not pressed, only the harpsichord tone is played, while the choir tone gradually comes in as the pedal is pressed. The volume of the choir tone is adjusted according to how much you press the pedal.
Octave	<p>When you play a key while pressing on the pedal, the note for the key being pressed and the note one octave above it are layered and played together.</p> <p>You can adjust the volume of the sound one octave above the layer tone by changing the pressure used on the pedal.</p>

NOTE

No effects will be applied with “Pedal EX” function assigned to the pedal if any tone other than the layer tone is selected.

- 5.** Press the [Function] (Exit) button so the indicator goes out.

Changing the Volume Balance of the Accompaniment and the Keyboard

You can also change the balance in the volume of songs or accompaniment and the volume of the keyboard as you play.

1. Press the [Function] (Exit) button so the indicator is lit.
2. Press the [Song] (Select -) button or [◀◀] (Select +) button to display the BALANCE screen.



```
BALANCE Key:Acmp=5:5
Layer=7:3
```

3. Press the [Song] (Select -) button or [◀◀] (Select +) button to get the value for “Key:Acmp” (Keyboard:Accompaniment) to flash.



```
BALANCE Key:Acmp=5:5
Layer=7:3
```

4. Press the [▶/■] (Value -) button or [▶▶] (Value +) button to adjust the accompaniment and the keyboard volume balance.

Value: 1:9-9:1

The volume increases as the value is raised.

5. Press the [Function] (Exit) button so the indicator goes out.

Remembering the Settings Even When the Power is Turned Off (Memory Backup)

Normally, the various settings revert to their default values when the power is turned off. However, you can specify that the settings will be remembered even when the power is turned off. This function is called “Memory Backup.”

1. Press the [Function] (Exit) button so the indicator is lit.
2. Press the [Song] (Select -) button or [◀◀] (Select +) button to display the MEMORY BACKUP screen.



```
MEMORY BACKUP
Press Enter to Exec.
```

3. Press the [Moving Key] button.

A confirmation message appears in the screen.



```
MEMORY BACKUP
Are you sure?
```

Pressing the [Function] (Exit) button at this point returns you to the original screen without the settings being saved.

4. Press the [Moving Key] button once more.

Memory Backup is executed.

When Memory Backup is finished, the display and buttons return to their normal appearance.



For more on the settings stored using Memory Backup, refer to “Parameters Stored in Memory Backup” (p. 109).

NOTE

Never turn off the power while “Executing...” is displayed in the screen. Doing so may corrupt the RG-7’s memory and render it unusable.

Restoring the Factory Settings (Factory Reset)

You can return the content stored with “Memory Backup” (refer to the previous page) to their original factory settings. This operation is referred to as “Factory Reset.”

1. Press the [Function] (Exit) button so the indicator is lit.
2. Press the [Song] (Select -) button or [◀◀] (Select +) button to display the FACTORY RESET screen.



FACTORY RESET
Press Enter to Exec.

3. Press the [Moving Key] button.

A confirmation message appears in the screen.

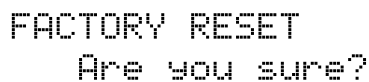

FACTORY RESET
Are you sure?

Pressing the [Function] (Exit) button at this point returns you to the original screen without Factory Reset being executed.

4. Press the [Moving Key] button once more.

Factory reset is executed.

When Factory Reset is finished, the display and buttons return to their normal appearance.

NOTE

When you perform a Factory Reset, all settings that have been stored in memory up to then are erased and reset to their factory defaults.

MEMO

When you want to restore the content registered to the RG-7's User memory to the factory condition, refer to “Initializing the User Memory or USB Memory” (p. 92).

NOTE

Never turn off the power while “Executing...” is displayed in the screen. Doing so may corrupt the RG-7's memory and render it unusable.

Chapter 4. Recording the Performance

■ Notes Regarding Recording

You can store your recorded performances to the “Favorites” (p. 25). If not first saved to the “Favorites,” recorded performances are erased when the RG-7’s power is turned off. If you want to retain such performances, be sure to save them to the “Favorites.”

You can also record your performances using external audio equipment (p. 97) and save performance data to USB memory (sold separately) connected to the Ext Memory port (p. 76).

Recording Performances

- 1** Select the tone you want to perform with (p. 53).
- 2** Press the [Function] (Exit) button, getting its indicator to light.
- 3** Press the [Song] (Select -) button or [I◀◀] (Select +) button to display the RECORD screen.



```
RECORD
      Press Enter
```

- 4** Press the [Moving Key] (Enter) button.
The following screen appears, and the RG-7 goes into recording standby.



```
RECORD
Press a key to start
```

Start Recording

- 5** Play the keyboard to begin recording.
Recording starts, and the following screen appears.
The text “Recording...” flashes while recording is in progress.



```
RECORD Recording...
Press Enter to stop.
```

Stopping Recording

6 Press the [Moving Key] (Enter) button.

Recording stops.

The following screen appears.

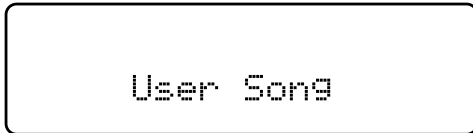

■ Play Back the Recorded Performance

1 Press the [▶/■] button.

You will hear the recorded performance.

Once again press the [▶/■] button, and playback will stop.

If you see the following...

If you attempt to select a song when another performance has already been recorded, the following appears in the display.

A rectangular screen with a black border displaying the text "Delete User Song OK?" on the first line and "No:Exit Yes:Enter" on the second line, both in a monospaced font.

```
Delete User Song OK?  
No:Exit Yes:Enter
```

If it is OK to erase the performance, press the [Moving Key] (Enter) button.

If you do not want to erase the performance, press the [Function] (Exit) button.



You can save recordings or your performances to the RG-7 itself (p. 76).

Saving Recorded Performances

If not first saved to the “Favorites” in the RG-7’s memory or to USB memory, recorded performances are erased when the RG-7’s power is turned off. If you want to retain such performances, be sure to save them to the “Favorites” or to USB memory.

- 1** Press the [Function] (Exit) button, getting its indicator to light.
- 2** Press the [Song] (Select -) button or [⏪] (Select +) button to display the FILE screen.

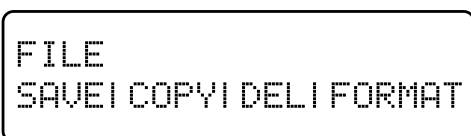

- 3** Press the [Song] (Select -) button or [⏪] (Select +) button so “SAVE” is flashing.

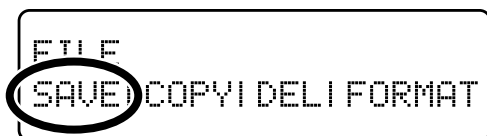

- 4** Press the [Moving Key] (Enter) button.
- 5.** Press the [Song] (Select -) button or [⏪] (Select +) button to get the value for “Dest” (Save Destination) to flash.



- 6** Press the [▶/■] (Value -) button or [▶▶] (Value +) button to change the “Dest” (Save Destination) setting.

Display	Description
Favorites	The performance data is saved to the “Favorites.”
Ext Memory	The performance data is saved to the “USB memory.”

- 7** Press the [Song] (Select -) button or [⏪] (Select +) button to get “save-destination number” to flash.

MEMO

You can copy performances saved to the “Favorites” to USB memory. You can also take performances saved to USB memory and copy them to the “Favorites” (p. 42).

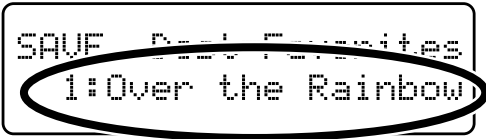

- 8** Press the [▶/■] (Value -) button or [▶▶] (Value +) button to select the “save-destination number.”

When a performance has already been saved to a number, the name of the performance is indicated.

When a number has no performance assigned to it, this is indicated in the display in the following form: “1: (Empty).”

- 9** Press the [Moving Key] (Enter) button.

The performance is saved.

- 10** Press the [Function] (Exit) button so the indicator goes out.

When a number has no song assigned to it, this is indicated in the display in the following form: “4: (Empty).”

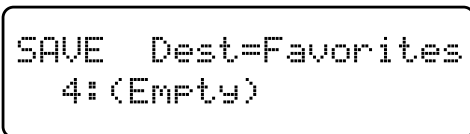

The following appears in the screen if you attempt to save a song to a number to which a song has already been saved.

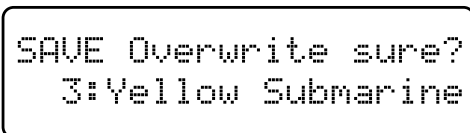

To delete the saved song and replace it by saving the current song, press the [Moving Key] (Enter) button. If you do not want to delete the saved song, press the [Function] (Exit) button to cancel saving.

NOTE

When saving performances to the USB memory, do not to remove the USB memory from the Ext Memory port until the save is completed.

■ Deleting Performances Saved to the “Favorites” or USB Memory

To delete performances saved to the “Favorites” or USB memory, refer to p. 45.

Chapter 5. User Program Registration

You can register the currently selected tone buttons, transposition and volume balance, and a variety of other settings as “favorite performance settings” (User Program). This allows you to call up the registered favorite performance settings whenever you need them. Registering the settings you often use is makes it even more convenient for you.



For more on what can be registered to a User Program, refer to “Parameters Stored in Memory Backup” (p. 109).

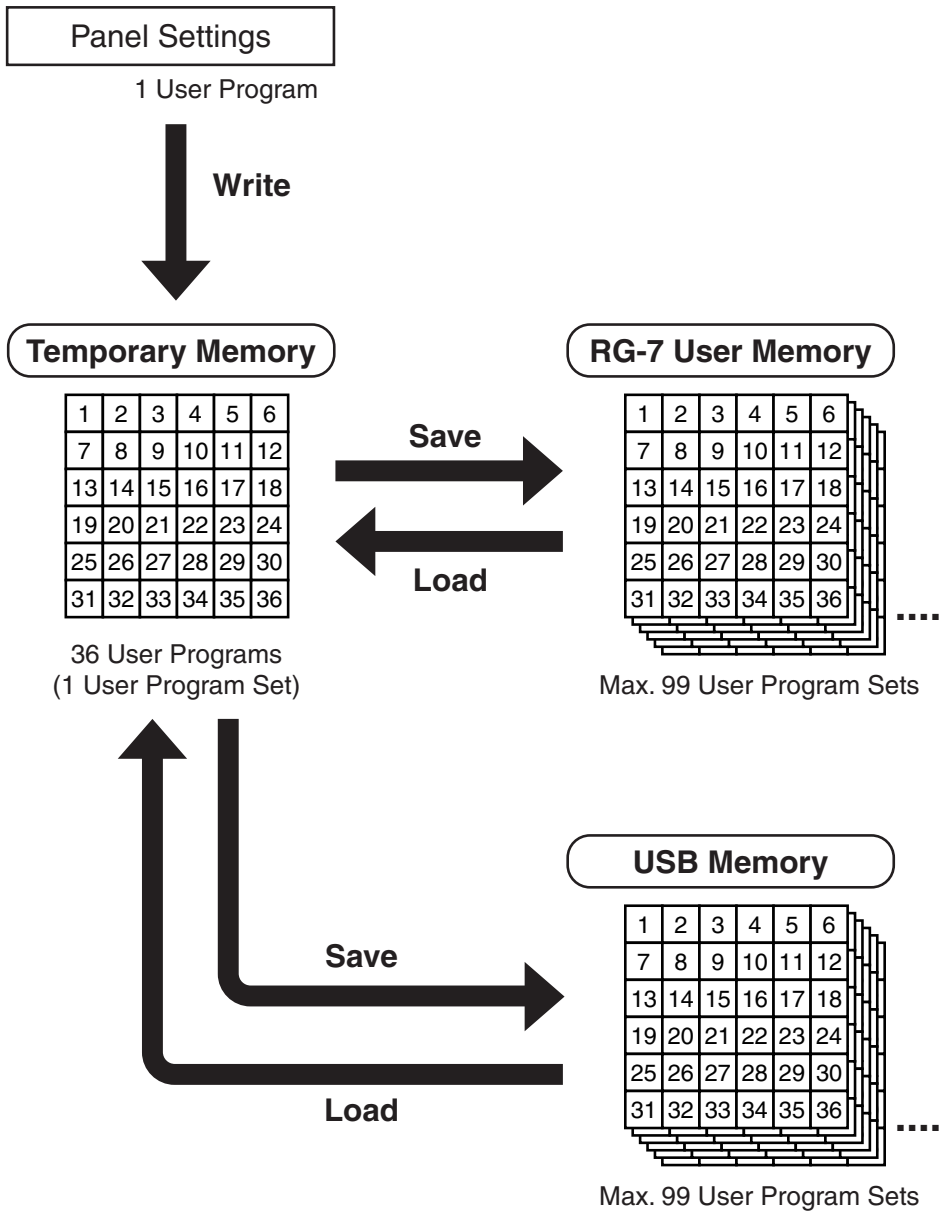

Saving Performance Settings (User Program)

You can register up to 36 User Programs to the RG-7.

- 1** Set the Tone, and other data until the settings are the way you want them.
- 2** Press the [Function] (Exit) button, getting its indicator to light.
- 3** Press the [Song] (Select -) button or [◀◀] (Select +) button to display the USER PROGRAM screen.



```

USER PROGRAM
WRITE|SAVE|LOAD|DEL
  
```

- 4** Press the [Song] (Select -) button or [◀◀] (Select +) button so "WRITE" is flashing.



```

USER PROGRAM
WRITE|SAVE|LOAD|DEL
  
```

- 5** Press the [Moving Key] (Enter) button.

The following screen appears.



```

USER PROGRAM WRITE
Write to UPG 01
  
```

- 6** Press the [▶/■] (Value -) button or [▶▶] (Value +) button to select the write-destination number.

Select a number from UPG 01 to UPG 36 as the performance settings write destination.



```

USER PROGRAM WRITE
Write to UPG 01
  
```

- 7** Press the [Moving Key] (Enter) button.

The currently selected performance settings are registered, and the USER PROGRAM screen returns to the display.

Calling Up Saved User Programs

You can easily call up User Programs.

- 1 Press the [Function] (Exit) button so the indicator goes out.
- 2 Hold down the [Function] (Exit) button and press the [▶/■] (Value -) button or [▶▶] (Value +) button to select the User Program you want to call up.



```
User Program 01
Electric Piano + Str
```

The display changes to indicate the registered buttons and other performance settings. The tone name registered in the User Program appears in the lower row of the screen.

Restoring the Standard Performance Settings (Settings in Effect When the Power is Turned On)

After you have called up User Programs, you can use the following procedure to restore the performance settings that are selected when the power is turned on.

- 1 Hold down the [Function] (Exit) button and press the [▶/■] (Value -) button to select "User Program 01."



```
User Program 01
Electric Piano + Str
```

- 2 While holding down the [Function] (Exit) button and the [▶/■] (Value -) button once again.

The following screen appears.



```
User Program Off
Normal Piano Mode
```

The favorite performance settings are cancelled, restoring the settings to their status when the power is turned on.



You can use the Pedal as a dedicated switch for selecting User Programs in order. For more details, refer to "Using the Pedal to Switch User Programs" (p. 87).

Saving the User Program Sets

The 36 separate configurations of User Programs registered in the RG-7 can be saved as sets in User Memory (p. 25) or to USB memory (sold separately).

When saving the settings to USB memory, connect the USB memory to the Ext Memory port (p. 22).

- 1** Press the [Function] (Exit) button, getting its indicator to light.
- 2** Press the [Song] (Select -) button or [◀◀] (Select +) button to display the USER PROGRAM screen.

```
USER PROGRAM
WRITE|SAVE|LOAD|DEL
```

- 3** Press the [Song] (Select -) button or [◀◀] (Select +) button so "SAVE" is flashing.

```
USER PROGRAM
WRITE (SAVE) |LOAD|DEL
```

- 4** Press the [Moving Key] (Enter) button.

The following screen appears.

```
SAVE Dest=UserMemory
1:UPG Set 01
```

- 5** Press the [Song] (Select -) button or [◀◀] (Select +) button so that the "User Program save destination" is flashing.

```
SAVE Dest.(UserMemory)
1:UPG Set 01
```

- 6** Press the [▶/■] (Value -) button or [▶▶] (Value +) button to select the "User Program save destination."

Display	Description
User Memory	The User Program is saved in User Memory.
Ext Memory	The User Program is saved in USB Memory.

MEMO

You can restore the content in the User Memory to the original default factory settings. Refer to "Restoring the Factory Settings (Factory Reset)" (p. 73).

NOTE

Use USB memory available from Roland. Proper operation cannot be guaranteed if other external memory products are used.

Chapter 5. User Program Registration

- 7** Press the [Song] (Select -) button or [I◀◀] (Select +) button so that the “User Program save-destination number” is flashing.



```
SAVE Dest=UserMemory
1:UPG Set 01
```

- 8** Press the [▶/■] (Value -) button or [▶▶] (Value +) button to select the “User Program save-destination number.”

Value: **UPG Set 01-UPG Set 99**

To return to the original screen without saving the User Program, press the [Function] (Exit) button.

- 9** Press the [Moving Key] (Enter) button.

The User Program is saved to the User memory or USB memory.

- 10** Press the [Function] (Exit) button so the indicator goes out.

When there is no User Program assigned to a number, this is indicated in the display in the following form: “2: (Empty).”



```
SAVE Dest=UserMemory
2:(Empty)
```

The following appears in the screen if you attempt to save a User Program to a number to which a User Program has already been saved.



```
SAVE Overwrite sure?
3:UPG Set 03
```

If you save performance settings to a number that already has User Programs saved to it, the previously saved User Programs are then deleted.

To delete the saved set of User Programs and save the new performance settings to that number, press the [Moving Key] (Enter) button. If you do not want to delete the saved User Programs, press the [Function] (Exit) button to cancel the save.

NOTE

Be sure not to turn off the power as long as “Executing...” is displayed. Turning off the power at this time may corrupt the USB memory and/or User Memory and render them unusable.

MEMO

When deleting the set of saved User Programs, refer to “Deleting Saved User Program Sets” (p. 85).

Loading Saved User Program Sets

You can load sets of User Programs saved in User Memory (p. 25) or to USB memory (sold separately) individually to the RG-7.

When loading User Programs from USB memory, connect the USB memory to the Ext Memory port (p. 22).

- 1** Press the [Function] (Exit) button, getting its indicator to light.
- 2** Press the [Song] (Select -) button or [◀◀] (Select +) button to display the USER PROGRAM screen.



```

USER PROGRAM
WRITE|SAVE|LOAD|DEL
  
```

- 3** Press the [Song] (Select -) button or [◀◀] (Select +) button so "LOAD" is flashing.



```

USER PROGRAM
WRITE|SAVE|LOAD|DEL
  
```

- 4** Press the [Moving Key] (Enter) button.

The following screen appears.



```

LOAD from UserMemory
1:UPG Set 01
  
```

- 5** Press the [Song] (Select -) button or [◀◀] (Select +) button so that the "User Program to be loaded" is flashing.



```

LOAD from UserMemory
1:UPG Set 01
  
```

NOTE

Note that when User Programs sets are loaded, all of the performance settings stored in the RG-7 are deleted.

Chapter 5. User Program Registration

- 6** Press the [▶/■] (Value -) button or [▶▶] (Value +) button to select the "User Program to be loaded."

Display	Description
User Memory	Loads User Programs saved in the User Memory.
Ext Memory	Loads User Programs saved in USB Memory.

- 7** Press the [Moving Key] (Enter) button.

- 8** Press the [Song] (Select -) button or [◀◀] (Select +) button so that the "load User Program number" is flashing.



- 9** Press the [▶/■] (Value -) button or [▶▶] (Value +) button to select the number for the User Program to be loaded.

- 10** Press the [Moving Key] (Enter) button.

A confirmation message appears in the screen.

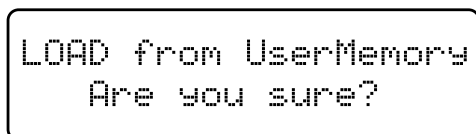

To return to the original screen without loading the User Program, press the [Function] (Exit) button.

- 11** Press the [Function] (Exit) button so the indicator goes out.

The selected User Program is loaded to the RG-7.

NOTE

When calling up User Programs saved in USB memory, do not to remove the USB memory from the Ext Memory port until the settings have been called up.

Deleting Saved User Program Sets

You can delete individual User Program sets saved to USB memory (sold separately) or in user memory (p. 25).

When deleting User Programs from USB memory, connect the USB memory to the Ext Memory port (p. 22).

- 1** Press the [Function] (Exit) button, getting its indicator to light.
- 2** Press the [Song] (Select -) button or [◀◀] (Select +) button to display the USER PROGRAM screen.



```

USER PROGRAM
WRITE|SAVE|LOAD|DEL
  
```

- 3** Press the [Song] (Select -) button or [◀◀] (Select +) button so that the "DEL" (Delete) is flashing.



```

USER PROGRAM
WRITE|SAVE|LOAD|DEL
  
```

- 4** Press the [Moving Key] (Enter) button.

The following screen appears.



```

DEL Dest=UserMemory
1:UPG Set 01
  
```

- 5** Press the [Song] (Select -) button or [◀◀] (Select +) button so that the "User Program to be deleted" is flashing.



```

DEL Dest=UserMemory
1:UPG Set 01
  
```

Chapter 5. User Program Registration

- 6** Press the [▶/■] (Value -) button or [▶▶] (Value +) button to select “save-destination of the User Program to be deleted.”

Display	Description
User Memory	Deletes the User Programs saved in the User Memory.
Ext Memory	Deletes the User Programs saved in USB Memory.

- 7** Press the [Song] (Select -) button or [◀◀] (Select +) button to get “the number of the User Program to be deleted.” to flash.



- 8** Press the [▶/■] (Value -) button or [▶▶] (Value +) button to select the “the number of the User Program to be deleted.”

- 9** Press the [Moving Key] (Enter) button.

A confirmation message appears in the screen.

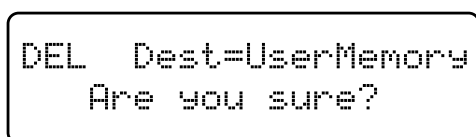

To return to the original screen without deleting the User Program, press the [Function] (Exit) button.

- 10** Press the [Moving Key] (Enter) button once more.

The selected User Program is deleted.

- 11** Press the [Function] (Exit) button so the indicator goes out.

NOTE

When deleting User Programs saved in USB memory, do not to remove the USB memory from the Ext Memory port until the delete is completed.

Using the Pedal to Switch User Programs

You can use the Pedal as a dedicated switch for selecting User Programs in order. The User Programs are switched each time the pedal is pressed.

- 1** Press the [Function] (Exit) button, getting its indicator to light.
- 2** Press the [Song] (Select -) button or [◀◀] (Select +) button to display the USER PROGRAM screen.

```

USER PROGRAM
Pedal Shift=   Off
  
```

- 3** Press the [Song] (Select -) button or [◀◀] (Select +) button so that the "Pedal Shift" is flashing.

```

USER PROGRAM
Pedal Shift=   Off
  
```

- 4** Press the [▶/■] (Value -) button or [▶▶] (Value +) button to select the pedal to be used for switching the Favorite performance settings.

Value	Description
Left	The left pedal is dedicated to switching User Programs. The function assigned to the left pedal cannot be used.
Center	The center pedal is dedicated to switching User Programs. The function assigned to the center pedal cannot be used.
Off	You can use a function assigned to the pedal. You cannot use the Pedal as a dedicated switch for selecting User Programs in order.

- 5** Press the [Function] (Exit) button so the indicator goes out.

The User Programs are switched each time you press the pedal to which the function of switching performance settings is assigned.

Chapter 6. Changing Various Settings

Changing the Moving Key Settings

■ Stopping the Keyboard Movement

Although you can have the keys of the RG-7's keyboard move in correspondence with songs as they are played back, you can also temporarily stop the movement of the keyboard.

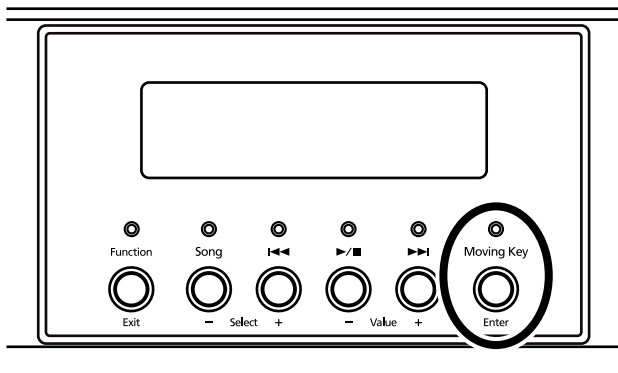

1. Press the [Moving Key] button so the indicator goes out.

Now the keyboard will not move in correspondence with the song being played back.

[Moving Key] indicator	Keyboard Function
Indicator lit	The keys play along with the performance.
Indicator off	The keys do not move.

You can assign the "Moving Key" function to the remote control's [FUNC 1] button or [FUNC 2] button and use the remote control buttons to switch the Moving Key function on and off (p. 35).

Making Detailed Settings

You can set the master tuning, temperament, and other settings that make the RG-7 easier to play. The screen in which the settings are changed is called the "Function screen."

How to Enter Function Mode

1. Press the [Function] (Exit) button, getting its indicator to light.

The following screen appears.

```
KEY TOUCH  Touch= 65
           Hammer=Light
```

2. Press the [Song] (Select -) button or [◀◀] (Select +) button to select the settings screen.

```
RESONANCE  KeyOff=4
           String=3 Damper=3
```

3. Press the [Song] (Select -) button or [◀◀] (Select +) button so the value of the parameter you want to change is flashing.

```
RESONANCE  KeyOff=4
           String=3 Damper=3
```

4. Press the [▶/■] (Value -) button or [▶▶] (Value +) button to change the value.

```
RESONANCE  KeyOff=4
           String=3 Damper=5
```

Press the [▶/■] (Value -) and [▶▶] (Value +) buttons simultaneously to restore the factory-set values.

→ If you want to continue making changes to other settings, press the [Song] (Select -) button or [◀◀] (Select +) button to switch the settings screen.

How to Exit Function Mode

1. Press the [Function] (Exit) button so the indicator goes out.

Changing the Part That Makes the Keys Move

With the RG-7, you can set the part to which the keyboard's movement is to be linked when the keyboard moves automatically along with a song.

SMF music files and other such songs are composed of 16 parts (channels), with various performances recorded to the different parts. For example, rhythm performances are often recorded to Part 10, while the right-hand keyboard performance is recorded to Part 4.

1. Press the [Function] (Exit) button, getting its indicator to light.
2. Press the [Song] (Select -) button or [◀◀] (Select +) button to display the "MISC Moving Key Part" screen.

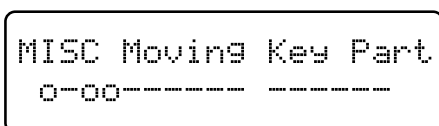

3. Press the [Moving Key] (Enter) button.
4. Press the [Song] (Select -) button or [◀◀] (Select +) button to select the part you want to change.



From the left, these are "part 1, part 2 ... part 15, and part 16."

5. Press the [▶/■] (Value -) button or [▶▶] (Value +) button to switch the keyboard movement on or off.

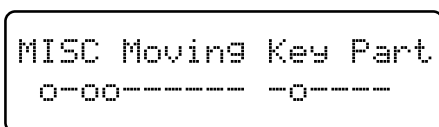

The part to which the moving keyboard is linked is indicated by "0" in the screen; parts that do not cause the keyboard to play are indicated by "-" in the screen.

MEMO

When having the keys play automatically to a performance recorded on the RG-7, select Part 1. In Split performances, however, the right-hand performance is recorded to Part "4," while the left hand is recorded to Part "3."

6. Press the [Function] (Exit) button so the indicator goes out.

Changing the Remote Control Settings

Disabling Use of the Remote Control

You can prevent the included remote control from controlling the RG-7 by turning the Remote Control function off. This prevents settings from being altered inadvertently if any buttons on the remote control are pressed by mistake.

→ The remote control's functions are switched on and off together with the infrared transmission function (p. 96). The remote control's functions are disabled when infrared transmission is turned off.

1. Press the [Function] (Exit) button, getting its indicator to light.
2. Press the [Song] (Select -) button or [◀◀] (Select +) button to display the REMOTE screen.

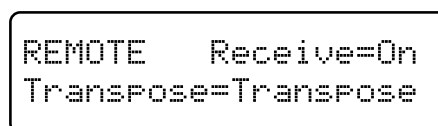

3. Press the [Song] (Select -) button or [◀◀] (Select +) button to get the value for "Receive" to flash.

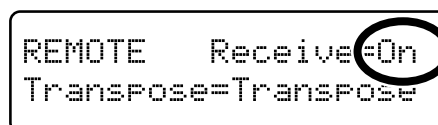

4. Press the [▶/■] (Value -) button or [▶▶] (Value +) button to switch the Remote Control function on or off.

Value	Description
On	The RG-7 can be controlled using the remote control.
Off	The remote control is disabled. * The infrared transmission functions used by external devices are also disabled.

5. Press the [Function] (Exit) button so the indicator goes out.

→ You can use the Memory Backup function to store these settings to the RG-7 (p. 72).

Chapter 6. Changing Various Settings

■ Changing the Functions of the Remote Control's Buttons

You can change the functions assigned to the remote control's buttons.

→ You can use the Memory Backup function to store these settings to the RG-7 (p. 72).

1. Press the [Function] (Exit) button, getting its indicator to light.
2. Press the [Song] (Select -) button or [◀◀] (Select +) button to display the REMOTE screen.

```
REMOTE  Receive=On
Transpose=Transpose
```

3. Press the [Song] (Select -) button or [◀◀] (Select +) button so that the value for the remote control's button whose function you want to change is flashing.

Value	Description
Transpose	Remote Control TRANSPOSE [-] [+] buttons
F1	Remote Control [FUNC 1] button
F2	Remote Control [FUNC 2] button

```
REMOTE  Receive=On
Transpose=Transpose
```

```
REMOTE  F1=Moving Key
F2=Random
```

4. Press the [▶/■] (Value -) button or [▶▶] (Value +) button to switch the function assigned to the remote control's buttons.

Functions Assigned to the TEMPO [-] and [+] Buttons

Value	Description
Transpose	Transposes the key of the song being played. Press the TRANSPOSE [-] button to lower the key; press the TRANSPOSE [+] button to raise the key.
Bwd/Fwd	Fast forwards and rewinds the song. When TEMPO [-] is pressed, the song rewinds; when TEMPO [+] is pressed, the song is fast forwarded.
CD Volume	Changing the volume of the Song on CDs (p. 91). Press the TEMPO [-] button to decrease the volume, and press the TEMPO [+] button to increase the volume.
CD Sync	This adjusts the timing of the piano accompaniment during playback of Player Piano CDs (p. 91). When TEMPO [-] is pressed, the piano sound is played earlier; when TEMPO [+] is pressed, the piano sound is played later.

Functions Assigned to the [FUNC 1] and [FUNC 2] Buttons

Value	Description
Moving Key	Switches Moving Key on and off.
Random	Plays back the songs in random order.
Equalizer	Switches the equalizer on and off (p. 60).
Minus One	Switches the minus one function on and off (p. 93).

5. Press the [Function] (Exit) button so the indicator goes out.

Changing the CD Settings

■ Adjusting the CD Level

This adjusts the CD volume during playback of CDs.

1. Press the [Function] (Exit) button, getting its indicator to light.
2. Press the [Song] (Select -) button or [◀◀] (Select +) button to display the CD screen.

```
CD           Level= 70
Mute=Auto   Sync= 50
```

3. Press the [Song] (Select -) button or [◀◀] (Select +) button to get the value for "Level" to flash.

```
CD           Level= 70
Mute=Auto   Sync= 50
```

4. Press the [▶/■] (Value -) button or [▶▶] (Value +) button to adjust the CD level.

Value: 0–127

Raising the value increases the volume level.

5. Press the [Function] (Exit) button so the indicator goes out.

→ You can use the Memory Backup function to store these settings to the RG-7 (p. 72).

■ Synchronizing the Timing of the Piano and Accompaniment

With certain CDs designed to be used with the player function, the timing of the piano and accompaniment sounds may not be synchronized. However, you can synchronize the piano and accompaniment.

1. Press the [Function] (Exit) button, getting its indicator to light.
2. Press the [Song] (Select -) button or [◀◀] (Select +) button to display the CD screen.
3. Press the [Song] (Select -) button or [◀◀] (Select +) button to get the value for "Sync" to flash.

```
CD           Level= 70
Mute=Auto   Sync= 50
```

4. Press the [▶/■] (Value -) button or [▶▶] (Value +) button to adjust the timing of the piano sound.

Value: 0–200

The piano sound is delayed more as the value is increased.

5. Press the [Function] (Exit) button so the indicator goes out.

■ Setting the Type of CD To Be Played Back

The RG-7 may be unable to correctly recognize the type of CD being used. In such instances, you can specify the type of CD manually.

1. Press the [Function] (Exit) button, getting its indicator to light.
2. Press the [Song] (Select -) button or [◀◀] (Select +) button to display the CD screen.
3. Press the [Song] (Select -) button or [◀◀] (Select +) button to get the value for "Mute" to flash.

```
CD           Level= 70
Mute=Auto   Sync= 50
```

4. Press the [▶/■] (Value -) button or [▶▶] (Value +) button to select the CD type.

Value	Description
Auto	The CD type is detected automatically.
Type A	General CDs for Player Piano contain audio and MIDI data, and the data format may vary from one CD to the next. If the CD's data format does not match the RG-7's settings, a "beep" will sound. Certain general Automatic Piano CDs may not be playable on the RG-7.
Type B	
Off	Commercial Audio CD (CDs other than those designed for use with the player piano)

NOTE

Note that some commercial player piano CDs cannot be played back on the RG-7.

5. Press the [Function] (Exit) button so the indicator goes out.

Initializing the User Memory or USB Memory

You can completely erase the content of the User Memory or USB memory and restore the original default factory settings (initializing).

The RG-7 contains an internal memory area to which you can save recorded performances and other data. This area is called the “User Memory.”

The following content is stored in the User Memory.

- Content registered in the “Favorites” (p. 25)
- Content in saved User Program (favorite performance settings) sets (p. 78)

1. To initialize your USB memory, first connect the USB memory to the Ext Memory port.
2. Press the [Function] (Exit) button, getting its indicator to light.
3. Press the [Song] (Select -) button or [◀◀] (Select +) button to display the FILE screen.
4. Press the [Song] (Select -) button or [◀◀] (Select +) button so “FORMAT” is flashing.



5. Press the [Moving Key] (Enter) button.
6. Press the [▶/■] (Value -) button or [▶▶] (Value +) button to select the memory to be initialized.



Value	Description
User Memory	Content of the User Memory
Ext Memory	Content of the USB memory connected to the Ext Memory port

7. Press the [Moving Key] (Enter) button.

A confirmation message appears in the screen.

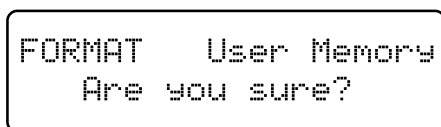

To return to the original screen without deleting the content of the User Memory or USB Memory, press the [Function] (Exit) button.

8. Press the [Moving Key] (Enter) button once more.

The content of the User Memory or USB Memory is deleted

- * **Be sure not to turn off the power as long as “Executing...” is displayed. Turning off the power at this time may corrupt the RG-7’s internal memory and render it unusable.**
- * *Executing this procedure does not initialize any settings other than the content of the User Memory. To restore the factory defaults for settings other than the User Memory content, carry out Factory Reset (p. 73).*

Using the V-LINK Function

Connecting the RG-7 to a V-LINK compatible image device allows you to control the images with the RG-7.

V-LINK

V-LINK (**V-LINK**) is a function that allows music and images to be performed together. By using MIDI to connect two or more V-LINK compatible devices, you can easily enjoy a wide range of visual effects that are linked to the expressive elements of a music performance.

1. Press the [Function] (Exit) button, getting its indicator to light.
2. Press the [Song] (Select -) button or [◀◀] (Select +) button to display the MIDI screen.
3. Press the [Song] (Select -) button or [◀◀] (Select +) button to get the value for “V-LINK” to flash.

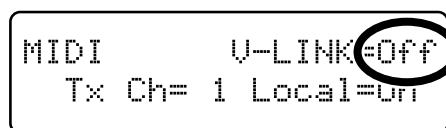

4. Press the [▶/■] (Value -) button or [▶▶] (Value +) button to switch the V-LINK function on or off.

Value	Description
On	The V-LINK function is switched on. You can control images using the twelve keys at the left end of the keyboard.
Off	The V-LINK function is switched off.

This is set to “Off” when you turn on the power.

NOTE

While V-LINK is switched on, no sound is produced when you press any of the twelve keys at the left end of the keyboard.

5. Press the [Function] (Exit) button so the indicator goes out.

Playing the Automatic Demos

You can set the RG-7 so that it automatically starts a demo performance when you turn it on.

You also can have a slide show of your favorite images play simultaneously in the connected external display or television.

Preparing the Songs to Be Played

1. After connecting the USB memory to the computer, create a folder named "AUTODEMO" on the USB memory.
2. Save the songs (SMF data) you want to have played in the "AUTODEMO" folder.
3. Connect the USB memory to the Ext Memory port of the RG-7 (p. 22).
4. Turn on the power to the RG-7.

After you turn on the power, the songs saved in the USB memory's "AUTODEMO" folder are played continuously. In addition, when you have your preferred images saved in the USB memory's "_PICTURE" folder, a slide show of the images is displayed on the connected external display or television.

When Running Slide Shows Through a Connected External Display or Television

5. Make sure the power to the RG-7 is turned off (p. 19), then connect the external display or television (p. 47, p. 49).

* You cannot use a television and external display simultaneously.

6. Prepare the images you want to have appear in the slide show and save them to the USB memory (p. 51).

Muting a Specific Part (Minus One)

You can temporarily mute any specific part. This temporary muting of a specified part is called "Minus One."

1. Press the [Function] (Exit) button, getting its indicator to light.
2. Press the [Song] (Select -) button or [◀◀] (Select +) button to display the PLAY screen.

```
PLAY   Mode=All Song
        Minus One=Off
```

3. Press the [Song] (Select -) button or [◀◀] (Select +) button to get the value for "Minus One" to flash.

```
PLAY   Mode=All Song
        Minus One=Off
```

4. Press the [▶/■] (Value -) button or [▶▶] (Value +) button to switch the Minus One function on and off.

Value	Description
On	The specified part is muted. Set the part to be muted in "Specifying the Part to Be Muted" (p. 94). * When Moving Keys is in use, it is not applied to the part muted with Minus One.
Off	Minus One is switched off.

Chapter 6. Changing Various Settings

Specifying the Part to Be Muted

1. Press the [Function] (Exit) button, getting its indicator to light.
2. Press the [Song] (Select -) button or [◀◀] (Select +) button to display the "MISC Minus One Part" screen.

```
MISC  Minus One Part
R [1] 2 [3][4]
```

3. Press the [Moving Key] (Enter) button.
4. Press the [Song] (Select -) button or [◀◀] (Select +) button to select the part to be muted.

```
MISC  Minus One Part
R [1] 2 [3][4]
```

Value	Description
R	Rhythm Part
1	Parts saved in performances recorded with the RG-7
2	Accompaniment Part
3	Left-hand Part
4	Right-hand Part

5. Press the [▶/■] (Value -) button or [▶▶] (Value +) button to switch the muting on or off.

```
MISC  Minus One Part
R [1][2][3][4]
```

The muted part is indicated by a square brackets ([]) next to the part number.

MEMO

Performances recorded on the RG-7 are saved to Part 1. In Split performances, however, the right-hand performance is recorded to Part "4," while the left hand is recorded to Part "3."

6. Press the [Function] (Exit) button so the indicator goes out.

Changing the Notation Display Settings

When displaying notations on a connected external display or television, you can change the parts that appear in the notation and the way the score is displayed.

1. Press the [Function] (Exit) button, getting its indicator to light.
2. Press the [Song] (Select -) button or [◀◀] (Select +) button to display the NOTATION screen.

```
NOTATION  Staff=L+R
Clef L=Auto R=Auto
```

3. Press the [Song] (Select -) button or [◀◀] (Select +) button to select the parameter whose settings you want to change.

```
NOTATION  Staff=L+R
Clef L=Auto R=Auto
```

```
NOTATION  Key=Auto
Part L=Auto R=Auto
```

Menu	Value	Description
Staff	L+R	Display the right and left hand parts notation.
	R	Display the right hand part notation.
	L	Display the left hand part notation.
Clef L	AUTO	Display is switched automatically.
	G	The left-hand part appears in the G (treble) clef staff.
	F	The left-hand part appears in the F (bass) clef staff.
Clef R	AUTO	Display is switched automatically.
	G	The right-hand part appears in the G (treble) clef staff.
	F	The right-hand part appears in the F (bass) clef staff.

Menu	Value	Description
Key	AUTO	Key is switched automatically.
	#x6, #x5, #x4, #x3, #x2, #, 0, b, bx2, bx3, bx4, bx5	Display the notation in the selected key.
Part L	1-16	Select the part to be displayed as the left hand part.
	AUTO	Part is switched automatically.
Part R	1-16	Select the part to be displayed as the right hand part.
	AUTO	Part is switched automatically.

4. Press the [▶/■] (Value -) button or [▶▶] (Value +) button to change the setting.
5. Press the [Function] (Exit) button so the indicator goes out.

Setting the Part to Which Harmonies Are Added (Harmony Part)

When “Data” is selected as the Harmony type and you sing along with the playback of the music data, harmonies consistent with the scale of the specified part are added (p. 40).

Use the following procedure to set the part to which harmonies are added.

1. Press the [Function] (Exit) button, getting its indicator to light.
2. Press the [Song] (Select -) button or [◀◀] (Select +) button to display the “MISC Harmony Part” screen.

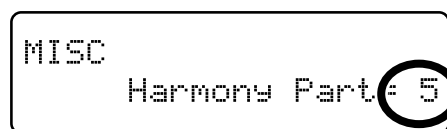

3. Press the [▶/■] (Value -) button or [▶▶] (Value +) button to switch the harmonized part.
Value: 1-16
4. Press the [Function] (Exit) button so the indicator goes out.

Chapter 6. Changing Various Settings

Changing the Infrared Transmission Function Settings

Some digital devices equipped with an IrDA (infrared) port are able to transfer song data in SMF format to the RG-7. For more detailed information, refer to the owner's manual for the digital device.

NOTE

Users are responsible for learning how to use infrared transmissions. The RG-7 is not necessarily compatible with all devices equipped with an IrDA port. Roland cannot answer questions regarding infrared transmissions.

■ Switching Infrared Transmissions On and Off (Infrared Function)

You can set whether to have the song data infrared transmission function on (active) or off (disabled).

→ The infrared transmission function is switched on and off together with the remote control's functions (p. 89). The infrared transmission function is disabled when remote control's function is turned off.

1. Press the [Function] (Exit) button, getting its indicator to light.
2. Press the [Song] (Select -) button or [◀◀] (Select +) button to display the REMOTE screen.

```
REMOTE  Receive=On
Transpose=Transpose
```

3. Press the [Song] (Select -) button or [◀◀] (Select +) button to get the value for "Receive" to flash.

```
REMOTE  Receive=On
Transpose=Transpose
```

4. Press the [▶/■] (Value -) button or [▶▶] (Value +) button to switch infrared transmission on or off.

Value	Description
On	The song data infrared transmission function is enabled.
Off	The song data infrared transmission function is disabled. Song data cannot be transferred. * The included remote control unit is also disabled.

5. Press the [Function] (Exit) button so the indicator goes out.

→ You can use the Memory Backup function to store these settings to the RG-7 (p. 72).

■ Setting Playback After the Song is Transferred (Infrared Playback)

This sets the RG-7 to play back a song automatically following transfer of the song from the digital device.

You can also set this so that songs are not played back automatically after the song is transferred.

1. Press the [Function] (Exit) button, getting its indicator to light.
2. Press the [Song] (Select -) button or [◀◀] (Select +) button to display the iR screen.

```
iR
iR Play=Auto
```

3. Press the [Song] (Select -) button or [◀◀] (Select +) button to get the value for "iR Play" to flash.

```
iR
iR Play=Auto
```

4. Press the [▶/■] (Value -) button or [▶▶] (Value +) button to switch the infrared playback function setting.

Value	Description
Auto	The song is played back automatically after the song is transferred.
Standby	Following transfer of the song, the song is ready to play but not played back.

5. Press the [Function] (Exit) button so the indicator goes out.

Chapter 7. Connecting External Devices

Connecting to Audio Equipment

You can connect audio devices to play the sound of the RG-7 through the speakers of your audio system, or to record your performance on a recording device.

Connectors

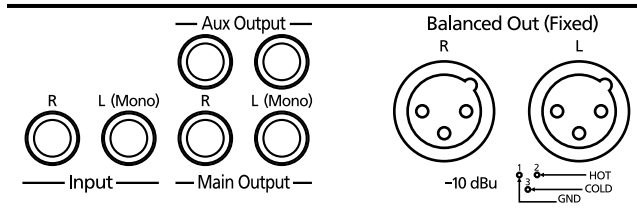

Output Jacks (Main Output/Aux Output)

You can connect audio equipment using audio cables (sold separately) and play the sounds from the RG-7 through the speakers on the connected equipment, or record your performances on a recording device.

If the input of the connected device is monaural, you must use the L (Mono) jack.

Input Jacks

You can connect another sound generator, such as audio equipment or an electronic instrument, using audio cables (sold separately). Play the sounds from the connected device through the speakers on the RG-7.

If the output of the connected device is monaural, you must use the L (Mono) jack.

* You cannot use the RG-7 to adjust the volume of the connected sound generating device.

About the Output jack

This instrument is equipped with balanced (XLR) type jacks. Wiring diagrams for these jacks are shown below. Make connections after first checking the wiring diagrams of other equipment you intend to connect.

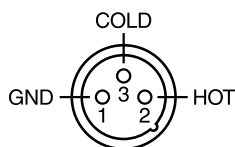

Making the Connections

NOTE

To prevent malfunction and/or damage to speakers or other devices, always turn down the volume, and turn off the power on all devices before making any connections.

Playing Sounds from the RG-7 Through the Speakers on Audio Equipment or Recording Your Performances on a Recording Device

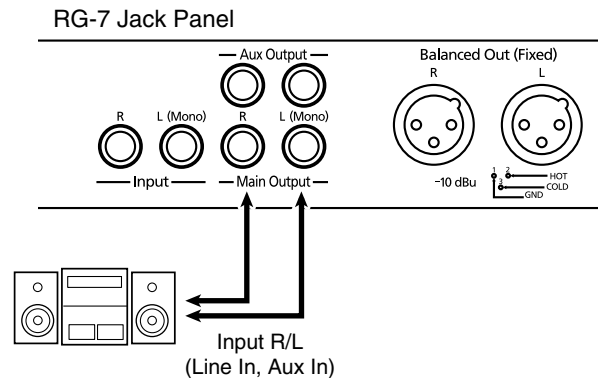

1. Turn the volume all the way down on the RG-7 and on the device you're about to connect.
2. Turn off the power to the RG-7 and other connected equipment.
3. Use audio cables (sold separately) to make the connection.
4. Switch on the RG-7.
5. Switch on the connected device.
6. Adjust the volume level on the RG-7 and the connected device.

→ You can adjust the volume of a connected sound module with the RG-7.

Recording RG-7 Performances on a Recording Device

7. Start recording with the connected device.
8. Play the keyboard.
9. When the performance ends, stop recording on the connected equipment.

Turning off the power

1. Set the volume of the RG-7 and of the connected devices to the minimum position.
2. Turn off the connected equipment.
3. Turn off the power to the RG-7.

Chapter 7. Connecting External Devices

Playing Audio Equipment Sounds Through the Speakers on the RG-7

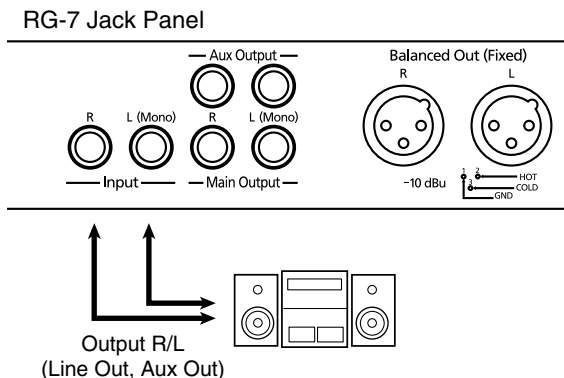

1. Turn the volume all the way down on the RG-7 and on the device you're about to connect.
2. Turn off the power to the RG-7 and other connected equipment.
3. Use audio cables (sold separately) to make the connection.
4. Turn on the connected equipment.
5. Turn on the RG-7.
6. Adjust the volume level on the RG-7 and the connected device.

* You cannot use the RG-7 to adjust the volume of the connected sound generating device.

Turning off the power

1. Set the volume of the RG-7 and of the connected devices to the minimum position.
2. Turn off the power to the RG-7.
3. Turn off the connected equipment.

Connecting External Speakers

You can connect external speakers and have what is played on the keyboard be output through the RG-7's speakers while the accompaniment is played through the connected external speakers.

Changing the Aux Output Jacks Settings

1. Press the [Function] (Exit) button, getting its indicator to light.
2. Press the [Song] (Select -) button or [◀◀] (Select +) button to display the AUX OUTPUT screen.

```
AUX OUTPUT
Mode=Surround
```

3. Press the [Song] (Select -) button or [◀◀] (Select +) button to get the value for "Mode" to flash.

```
AUX OUTPUT
Mode=Surround
```

4. Press the [▶/■] (Value -) button or [▶▶] (Value +) button to change the setting.

Indication	Description
Ensemble	Select this when playing the keyboard performance through the RG-7's internal speaker and the accompaniment sound through an amp or speaker connected to the Aux jack.
Surround	The sounds played with the keyboard and the accompaniment sounds are played through the RG-7's speakers, and the accompaniment sound with reverb applied is played through the speakers connected to the Aux Output jacks. Playing the accompaniment sound with reverb from external speakers the effect of being enveloped by the performance (Surround effect).
Off	No sound is heard through an amp or speaker connected to the Aux jack.

5. Press the [Function] (Exit) button so the indicator goes out.

■ Setup Examples With Aux Output Set to "Surround"

The piano sound is played through the RG-7's speaker, and the surround sound is played through the external speaker.

Spacious Location

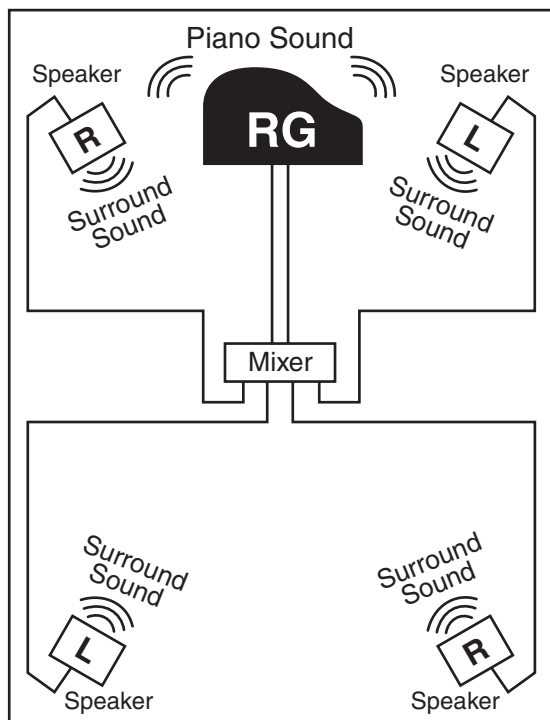

Location Limited in Space

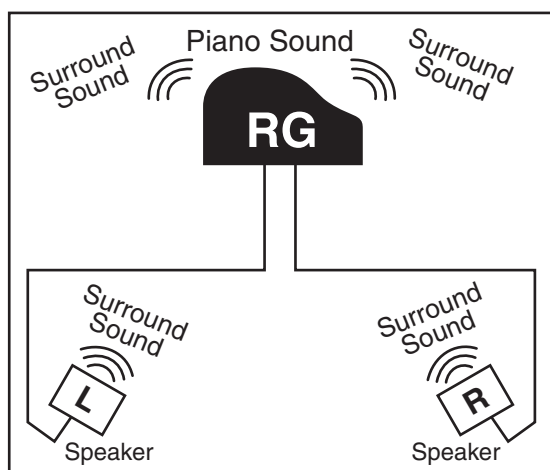

Connecting MIDI Devices

By connecting an external MIDI device and exchanging performance data, you can control one device from the other. For instance, you can output sound from the other instrument or switch Tones on the other instrument.

■ What's MIDI?

MIDI, short for "Musical Instrument Digital Interface," was developed as a universal standard for the exchange of performance data between electronic instruments and computers.

The RG-7 is equipped with MIDI connectors to let it exchange performance data with external devices. These connectors can be used to connect the RG-7 to an external device for even greater versatility.

* A separate publication titled "MIDI Implementation" is also available. It provides complete details concerning the way MIDI has been implemented on this unit. If you should require this publication (such as when you intend to carry out byte-level programming), please contact the nearest Roland Service Center or authorized Roland distributor.

■ Connectors

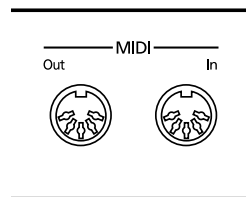

MIDI Out Connector

Connect this to the MIDI In connector on an external MIDI device using a MIDI cable (sold separately).

Performance data when you play the keyboard or depress a pedal is sent from this connector to the external MIDI connector.

MIDI In Connector

Connect this to the MIDI Out connector on an external MIDI device using a MIDI cable (sold separately).

This receives MIDI messages that are sent from external MIDI devices. The RG-7 receiving MIDI messages can output sounds, exchange tones and perform other operations.

* External MIDI devices can't be used for remotely changing the Tones played by the RG-7's keyboard.

Chapter 7. Connecting External Devices

■ Making the Connections

NOTE

To prevent malfunction and/or damage to speakers or other devices, always turn down the volume, and turn off the power on all devices before making any connections.

1. Turn the volume all the way down on the RG-7 and on the device you're about to connect.
2. Switch off the power to the RG-7 and the device you're about to connect.
3. Use a MIDI cable (sold separately) to connect the MIDI connectors to each other.
Please refer to the connection examples below.
4. Switch on the power to the RG-7 and the connected device.
5. Adjust the volume level on the RG-7 and the connected device.
6. You should also set the MIDI settings as needed.

For details on the MIDI-related settings, refer to previous section.

Connection Examples: Setup with a MIDI Sequencer

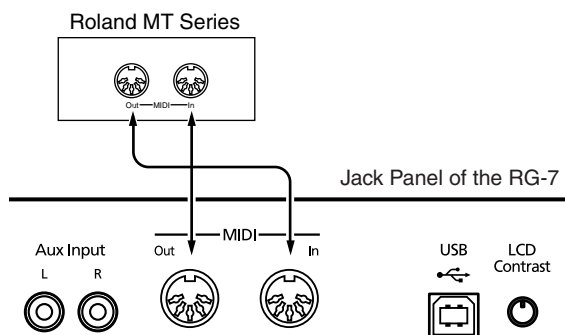

* When the RG-7 is connected to a MIDI sequencer, set it to Local OFF. Refer to "Disconnecting the Internal Sound Generator and Keyboard (Local Control)" (p. 101).

Connecting with a MIDI Sound Module

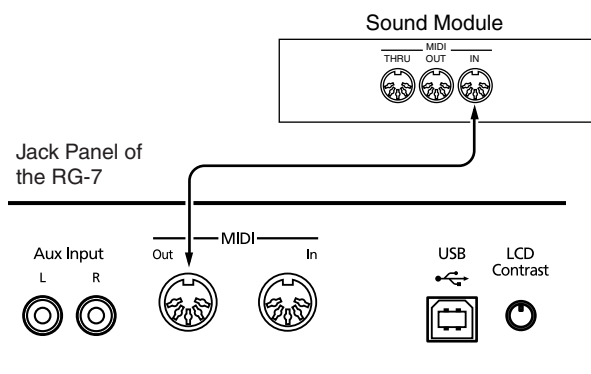

Making MIDI-related Settings

Here's how you can set the transmit channel and other MIDI-related settings.

■ MIDI Send Channel Settings

MIDI features sixteen MIDI channels, numbered 1–16. Simply connecting a cable is not enough for communication to take place. The connected devices must be set to use the same MIDI channels. Otherwise, no sound will be produced, and no sounds can be selected.

The RG-7 receives all channels 1–16.

1. Press the [Function] (Exit) button, getting its indicator to light.
2. Press the [Song] (Select -) button or [◀◀] (Select +) button to display the MIDI screen.

```
MIDI      U-LINK=Off
Tx Ch= 1 Local=On
```

3. Press the [Song] (Select -) button or [◀◀] (Select +) button to get the value for "Tx Ch" (Transmit channel) to flash.

```
MIDI      U-LINK=Off
Tx Ch= 1 Local=On
```

4. Press the [▶/■] (Value -) button or [▶▶] (Value +) button to set the MIDI Transmit channel.

Value: 1–16

5. Press the [Function] (Exit) button so the indicator goes out.

■ Disconnecting the Internal Sound Generator and Keyboard (Local Control)

When connecting a MIDI sequencer, set Local Control to "OFF." The setting is at "Local Control ON" when the RG-7 is powered up.

As illustrated, information describing what has been played on the keyboard is passed to the sound module over two different routes, (1) and (2). As a result, you hear overlapping or intermittent sounds. To prevent this from happening, route (1) must be disabled, by setting the unit to what is known as "Local Off."

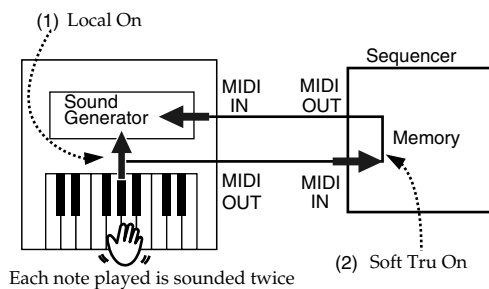

Local On:

The keyboard and internal sound generator are connected.

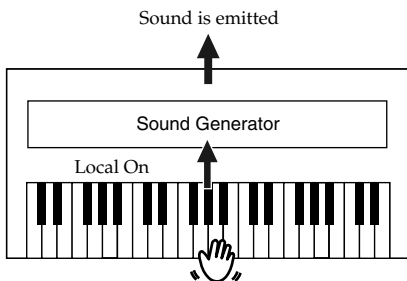

Local Off:

The keyboard and internal sound generator are separated. No sound will be produced by the keyboard when it is played.

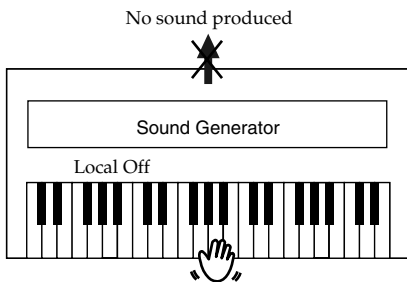

→ When connecting a unit in the Roland MT series, you don't need to switch off Local Control. MT units transmit Local Off messages when their power is switched on. If you first switch on the RG-7, then the MT-series device, Local Control is automatically switched off on the RG-7.

1. Press the [Function] (Exit) button, getting its indicator to light.
2. Press the [Song] (Select -) button or [◀◀] (Select +) button to display the MIDI screen.

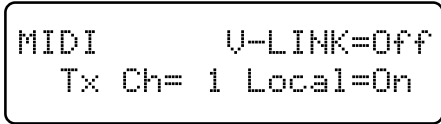

3. Press the [Song] (Select -) button or [◀◀] (Select +) button to get the value for "Local" (Local Control) to flash.

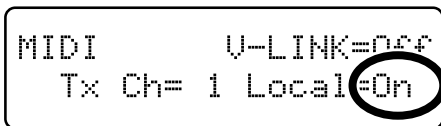

4. Press the [▶/■] (Value -) button or [▶▶] (Value +) button to switch Local Control on or off.

Value	Description
On	Local Control is switched on.
Off	Local Control is switched off.

5. Press the [Function] (Exit) button so the indicator goes out.

■ Sending Tone Change Messages (Program Change/Bank Select MSB/Bank Select LSB)

A Program Change is a message that means "change to the Tone of the specified number." The device that receives this changes to the Tone of the corresponding number.

When you choose a Program Change message (Program Number), the Program Number will be transmitted to the MIDI device connected to the RG-7. The MIDI device that receives the Program Number changes the tone to the corresponding Program Number.

Normally, the Tone is selected from the 128 Tones available. Some MIDI devices, however, have more than 128 Tones. With such devices, the Tone is selected through a combination of Program Change messages and Bank Select messages. There are two parts of a Bank Select message: the MSB (Controller 0, with a value of 0–127) and the LSB (Controller 32, with a value of 0–127).

* Some MIDI instruments can't handle Bank Select messages. Others can handle Bank Selects, but do not recognize the LSB part.

Chapter 7. Connecting External Devices

→ For more information on the tones switched when Program Changes are received, refer to the MIDI Implementation (sold separately). Order the MIDI Implementation from your RG-7 dealer.

1. Press the [Function] (Exit) button, getting its indicator to light.
2. Press the [Song] (Select -) button or [◀◀] (Select +) button to display the MIDI screen.

```
MIDI      U-LINK=Off
Tx Ch= 1 Local=On
```

3. Press the [Song] (Select -) button or [◀◀] (Select +) button so that the value set for “Bank Select MSB,” “Bank Select LSB,” or “PC” is flashing.

```
MIDI Ch-- PC=127(7F)
Bank 127(7F):128(7F)
```

┆
┆

 Bank Select MSB Bank Select LSB

Ch: **Setting the MIDI Channel Used for Transmitting Program Change Numbers When Switching User Programs**

PC: **Program Change Number**

Bank Select MSB: **Bank Select MSB**

Bank Select LSB: **Bank Select LSB**

4. Press the [▶/■] (Value -) button or [▶▶] (Value +) button to set the Program Change number, Bank Select MSB, or Bank Select LSB.

Menu	Value
Ch (User Program Transmit Channel)	-- (Off), 1–16 * When set to -- (Off), no Program Change Number is transmitted, even when User programs are switched.
PC	1–128
Bank Select MSB	0–127
Bank Select LSB	0–127

5. Press the [Function] (Exit) button so the indicator goes out.

■ Sending Recorded Performance Data to a MIDI Device (Composer MIDI Out)

When Composer MIDI Out is active, you can send performance data recorded with the RG-7 to a connected MIDI device or computer.

When you turn on the power, this is set to “Off” (data is not sent).

If you want to transmit a performance recorded on the RG-7 to an external MIDI device or computer, turn this setting “On.” If this is “Off,” the data will not be transmitted.

1. Press the [Function] (Exit) button, getting its indicator to light.
2. Press the [Song] (Select -) button or [◀◀] (Select +) button to display the MIDI screen.

```
MIDI      U-LINK=Off
Tx Ch= 1 Local=On
```

3. Press the [Song] (Select -) button or [◀◀] (Select +) button to get the value for “Composer MIDI Out” to flash.

```
MIDI
Composer MIDIOut=Off
```

4. Press the [▶/■] (Value -) button or [▶▶] (Value +) button to switch the song’s MIDI Out setting on or off.

Value	Description
On	The performance data recorded with the RG-7 can be sent to the connected MIDI device or computer.
Off	The performance data recorded with the RG-7 cannot be sent to the connected MIDI device or computer.

5. Press the [Function] (Exit) button so the indicator goes out.

If you wish to save the performance recorded on the RG-7, use the following procedure. In this situation, your external sequencer is set its MIDI Thru feature to be OFF. For details, refer to the owner's manual of your MIDI sequencer.

1. Connect a MIDI sequencer such as the MT series (p. 100).
2. Record the performance on the RG-7 (p. 74).
3. Set this setting to "On."
4. Start recording with the connected MIDI sequencer.
5. Start playback of the recorded song on the RG-7.
6. When playback ends, stop recording with the connected MIDI sequencer.
7. Use a connected MIDI sequencer to save the data on a floppy disk or other media.

Connecting to the Computer

You can use a USB connector to connect the RG-7 to your computer.

For more details, refer to the separate "USB Installation Guide."

- * Connecting your computer to the RG-7 for the first time requires installation of the "USB Driver" (on the included CD-ROM) to the computer.
- * Only MIDI data can be transmitted using USB.
- * To prevent malfunction and/or damage to speakers or other devices, always turn down the volume, and turn off the power on all devices before making any connections.
- * USB cables are not included. Consult your Roland dealer if you need to purchase.
- * Turn on the power to the RG-7 before starting up MIDI applications on the computer. Do not turn the RG-7 on or off while any MIDI application is running.
- * If not using USB, disconnect the USB cable from the RG-7.
- * If during the transmission/reception of data, the computer switches to energy-saving mode or suspended mode, or if the RG-7's power is switched on or off, the computer may freeze, or the RG-7's operation may become unstable.

For more on system requirements, refer to the "USB Installation Guide." However, note that the RG-7 is not compatible with Mac OS 9.

Making the Settings for the USB Driver

If you intend to connect to a computer using the USB connector, you need to make the following setting before you make the connection.

In the factory settings, "Original" is selected. Normally, there is no need to change the USB driver settings.

1. Press the [Function] (Exit) button, getting its indicator to light.
2. Press the [Song] (Select -) button or [◀◀] (Select +) button to display the MIDI screen.

```
MIDI
USB Driver=Original
```

3. Press the [Song] (Select -) button or [◀◀] (Select +) button to get the value for "USB Driver" to flash.

```
MIDI
USB Driver=Original
```

4. Press the [▶/■] (Value -) button or [▶▶] (Value +) button to select the USB driver.

Indication	Description
Generic	Select this when using a generic USB driver included with the OS with a USB connection.
Original	Select this when using the supplied driver with a USB connection. Under ordinary circumstances, use this mode.
Original2	This is an auxiliary mode. It is not normally used.

5. Press the [Function] (Exit) button so the indicator goes out.

Troubleshooting

If you think there's a problem, read this first.

Case	Cause/Remedy
The power doesn't come on	Is the power cord connected and plugged in correctly? (p. 19)
Depressing a pedal has no effect, or the pedal effect doesn't stop	Is the pedal connected correctly? Make sure the pedal cord is securely connected to the pedal connector (p. 19).
	Has a different function been assigned to the pedal? See "Assigning Functions to Pedals" (p. 69).
The volume level of the instrument connected to Input jacks is too low	Could you be using a connection cable that contains a resistor? Use a connection cable that does not contain a resistor.
Low hum coming from external device	Do you have different external devices plugged into different power outlets? When connecting external devices, always draw power from the same outlet.
Unable to load properly with USB memory	Is the USB memory you are using one that was produced by Roland? Performance is not guaranteed when other types of USB memory are used.
Volume of microphone changes	The microphone volume may change if the [Volume] button is adjusted while the Vocal Effect is on. The microphone volume does not change when the Vocal Effect is switched off.
Connected Television or External Display Screen Looks Odd	
Images not shown on external display or television when external display or television is connected	Is the external display or television properly connected? (p. 47, p. 49)
	Is the external display's power turned on?
	Are you using a display that is compatible with the RG-7? Refer to "Displays That Can Be Connected to This Instrument" (p. 47).
	Is the television format or display setting correct? (p. 47, p. 49)
Thin horizontal lines visible in the television screen	While narrow horizontal lines may be visible in the television screen, this is a particular characteristic of the television set and does not indicate any problem with the RG-7.
Poor-quality of images displayed in television	Even when all recommended settings are used, images may still not be displayed well with the television set you are using (images may not match the screen size, and may be clustered towards the center of the screen).

Case	Cause/Remedy
No sound is heard	
No sound is heard	Is the volume level of the RG-7 (p. 20) or connected device turned all the way down?
	Are headphones plugged in? (p. 21) Has a plug remained connected to the Phones jack? When headphones or plugs are connected, the keyboard's speaker stops playing.
	Could the keyboard volume be turned down completely in the volume balance settings? (p. 71)
	Could the levels of all frequency ranges be turned down completely in the equalizer settings? (p. 60)
No sound is heard (when a MIDI instrument is connected)	Is V-LINK switched on? While V-LINK is switched on, no sound is produced when you press any of the twelve keys at the left end of the keyboard (p. 92).
	Have all devices been switched on?
	Are the MIDI cables connected correctly? (p. 99)
No sound is heard when the keyboard is played	Does the MIDI channel match the connected instrument? (p. 100)
	Has Local Control been set to "Off"? When Local Control is set to Off, no sound is produced by playing the keyboard. Set Local Control to On (p. 101).
Not all played notes are sounded	The maximum number of notes can play simultaneously is 128. Frequent use of the damper pedal during playing along with a song may result in performance data with too many notes, causing some notes to drop out.
The sound is strange	
Sounds are heard twice (doubled) when the keyboard is played	Do you have the Layer tone selected? (p. 54)
	When the RG-7 is connected to an external sequencer, set it to the Local Off mode (p. 101). Alternatively, the sequencer could be set so its Soft Thru feature is Off.
The tuning or pitch of the keyboard or song is off	Have you set transpose? (p. 38, p. 61)
	Are the settings for the "Temperament" and "Stretch Tuning" correct? (p. 63, p. 64)
	Is the setting for the "Master Tune" correct? (p. 62)

Case	Cause/Remedy
Reverberation still audible even with Reverb turned off	Since the RG-7's piano sounds accurately reproduce the depth and reverberation of the original acoustic piano, you may find that reverberation is audible when the Key Off function is enabled. If you want to eliminate the reverberation, turn off the Key Off function (p. 57).
In the upper range, the sound changes abruptly beyond a certain key	On an acoustic piano, notes in the upper one and a half octaves of the keyboard continue to sound until they decay naturally, regardless of the damper pedal. There is a difference in the timbre as well. Roland pianos faithfully simulate such characteristics of the acoustic piano. On the RG-7, the range that is unaffected by the damper pedal will change depending on the Key Transpose setting.
A High-pitched whine is produced	When listening through headphones: Some of the more flamboyant and effervescent piano tones feature an ample high-end component, which may make the sound appear to have metallic reverberation added. Since this reverberation becomes particularly audible when supplemented by heavy reverb, you may be able to diminish the problem by reducing the amount of reverb applied to the sound. When listening through speakers: Here, a different cause (such as resonance produced by the RG-7) would be suspect. Consult your Roland dealer or nearest Roland Service Center.
The bass range sounds odd, or there is a vibrating resonance	When listening through speakers: Playing at loud volumes may cause instruments near the RG-7 to resonate. Resonance can also occur with fluorescent light tubes, glass doors, and other objects. In particular, this problem occurs more easily when the bass component is increased, and when the sound is played at higher volumes. Use the following measures to suppress such resonance. o Place speakers so they are 10-15 cm from walls and other surfaces. o Reduce the volume. o Move the speakers away from any resonating objects. When listening through headphones: Here, a different cause (such as resonance produced by the RG-7) would be suspect. Consult your Roland dealer or nearest Roland Service Center.

Case	Cause/Remedy
Song doesn't play back correctly	
Song doesn't play back	Does the screen indicate message, like "Delete User Song OK?" (p. 75). The internal songs cannot be played back while recorded performance data remains in the RG-7's memory. Erase the performance data or play back the song after saving to the "Favorites" or to your USB memory.
Pressing the [◀◀] button doesn't return to the beginning of the song	Some music files may contain settings that stop play at a point partway through the song. Press the [◀◀] button several times more to return to the beginning of the tune.
The [◀◀] and [▶▶] buttons don't work	The fast-forward and reverse buttons are ignored while music files is being read in. Wait until processing finishes.
Accompaniment not playing	Is the accompaniment volume turned down in the volume balance settings? (p. 71)
Can't record	
The recorded performance has disappeared	Any performance that has been recorded is deleted when the power to the RG-7 is turned off or a song is selected. A performance cannot be restored once it's been deleted. Be sure to save it on a USB memory or User Memory before you turn off the power (p. 92).
Unable to play back songs	Could you have pressed the remote control's [MUTE] button and muted the sound? Press the [MUTE] button to cancel the mute (p. 35).
Moving Key not working	Could the [Moving Key] indicator be extinguished? Press the [Moving Key] button so its indicator is lit.
	If using the Moving Key function, which part's performance is the Moving Key function assigned to play (p. 88)? Does the part to be played with the Moving Key function contain performance data? If a part containing no performance data is selected, the keys will not move when the song is played back. When running Moving Keys for a performance recorded with the RG-7, select Part 1.

Error Messages

Indication	Meaning
Error 01:	You can only read the music file. It can not be saved.
Error 02:	An error occurred during writing. The storage media's protect tab may be in the "Protect" (writing prohibited) position, or the storage media may not yet be initialized.
Error 10:	No storage media is inserted. Insert the storage media and try again.
Error 11:	There is not sufficient free memory in the save destination. Either insert other storage media or delete unneeded files and try again.
Error 14:	An error occurred during writing. The storage media may be corrupted. Insert other storage media and try again. Alternatively, you can initialize the storage media.
Error 15:	The file is unreadable. The data format is not compatible with the RG-7.
Error 16:	Data was not called up in time for playback of the song. After waiting several seconds, you may be able to play back the song by pressing the [▶/■] button again.
Error 17:	The selected image data cannot be displayed. Prepare image data that can be used with the RG-7 (p. 51).
Error 30:	The internal memory capacity of the RG-7 is full.
Error 40:	The RG-7 cannot deal with the excessive MIDI data sent from the external MIDI device. Reduce the amount of MIDI data sent to the RG-7.
Error 41:	A MIDI cable has been disconnected. Connect it properly and securely.
Error 43:	A MIDI transmission error has occurred. Check the MIDI cable and connected MIDI device.
Error 51:	There may be a problem with the system. Repeat the procedure from the beginning. If it is not solved after you have tried several times, contact the Roland service center.
Error 60:	
Error 61:	
Error 62:	
Error 63:	
Error 65:	The Ext Memory port was subjected to excessive current. Check the storage media to confirm that no damage has occurred to it.

Tone List

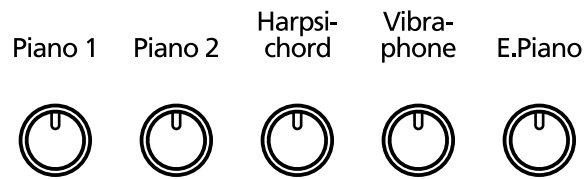

■ Piano 1

- 1 Superior Grand
- 2 Superior Grand + Str
- 3 Superior Grand + Pad
- 4 Piano + FM E.Piano

■ Piano 2

- 1 Natural Grand
- 2 Natural Grand + Str
- 3 Natural Grand + Pad
- 4 Piano + Bell

■ Harpsichord

- 1 Harpsichord
- 2 Coupled Harpsichord
- 3 Harpsichord + Choir
- 4 Harpsichord + Str

■ Vibraphone

- 1 Vibraphone
- 2 Bell
- 3 Harp
- 4 Electric Piano + Pad

■ E.Piano

- 1 Electric Piano
- 2 FM E.Piano
- 3 '60s Electric Piano
- 4 Electric Piano + Str

Tone Settings When Using the Split Function (p. 66) (Tone Number Left-Hand Tone / Right-Hand Tone)

■ Piano 1

- 1 A.Bs / SuperiorGrand
- 2 A.Bs/SuperiorGnd+Str
- 3 A.Bs/SuperiorGnd+Pad
- 4 Choir/Piano+FM E.Pno

■ Piano 2

- 1 Bs+Ride/NaturalGrand
- 2 Bs+Ride/Natural+Str
- 3 Bs+Ride/Natural+Pad
- 4 Choir / Piano + Bell

■ Harpsichord

- 1 Strings/Harpsichord
- 2 Strings/Coupled Hrps
- 3 Strings/Harpsi+Choir
- 4 Choir/Harpsichrd+Str

■ Vibraphone

- 1 A.Bs+Ride/Vibraphone
- 2 Choir / Bell
- 3 Strings / Harp
- 4 Choir/E.Piano + Pad

■ E.Piano

- 1 E.Bass/ElectricPiano
- 2 E.Bass / FM E.Piano
- 3 E.Bass/'60s E.Piano
- 4 Choir/E.Piano + Str

Internal Song List

Jazz
Trio Grande
Scrambled Egg
Blue Sky Rag
One Down And Easy
Bop On The Rock
Fly Free
Late Night Chopin
Wedding Song
Yesterday's Dream
Sun Daze
Keepers Tale
Kismet's Salsa
Roll Over Ludwig
A Prelude To ...
From Matthew's Passion
Hungarian Rag
Paganini Boogie

Classical
Liebestraume 3
Etude op10-3
Je te veux
Valse op64-1
Golliwog's Cakewalk
Fantaisie Impromptu
Arabesque 1
Nocturne No.2
Gymnopedie 1
Clair De Lune
Blauen Donau
Auf Flugeln des Gesanges
Mazurka No.5
Etude op25-1
Etude op10-5
Grande Valse Brillante
Course en Troika
Valse op64-2
Traumerei
Fruhlingslied
Dr. Gradus Ad Parnassum
Radetzky Marsch
Moments Musicaux 3
Prelude op28-15
Ungarische Tanze 5
La priere d'une Vierge
To The Spring
Humoreske
Blumenlied
Gavotte

* All rights reserved. Unauthorized use of this material for purposes other than private, personal enjoyment is a violation of applicable laws.

* No data for the music that is played will be output from MIDI OUT.

Parameters Stored to Internal Memory

■ Parameters Stored in Memory Backup

Screen	Display	Description	Page
KEY TOUCH	Touch	Key Touch	p. 55
	Hammer	Hummer Response	p. 56
RESONANCE	KeyOff	Key Off Resonance	p. 57
	String	String Resonance	p. 58
	Damper	Damper Resonance	p. 59
EQUALIZER	Master	Master Level	p. 60
	L	Low-frequency Range Level	p. 60
	M	Midrange Level	p. 60
	H	High-frequency Range Level	p. 60
TUNE	(Master Tune setting)	Master Tune	p. 62
	Stretch	Stretch Tune	p. 63
	(Tuning Method)	Temperament	p. 64
	Key	Tonic Note	p. 65
EFFECT	Reverb	Reverb Level	p. 68
REMOTE	Receive	Remote Control Function On/Off, Infrared Transmission Function On/Off	p. 89, p. 96
	Transpose	The Function Assigned to the Remote Control's [TRANSCOPE] Button	p. 90
	F1	The Function Assigned to the Remote Control's [F1] Button	p. 90
	F2	The Function Assigned to the Remote Control's [F2] Button	p. 90
EXT DISPLAY	VGA, NTSC, PAL	External Display Setting and Television Format	p. 48, p. 49
	Slide Interval	The Duration for Displaying Slide Show Images	p. 51
AUX INPUT	Level	AUX INPUT Level	p. 36
	Mode	AUX INPUT Mode	p. 36
PLAY	Mode	Song Playback Method	p. 27
CD	Level	CD Level	p. 91

■ Parameters Stored in the User Program

Screen	Display	Description	Page
---	---	Selected Tone and Variation	p. 53
EFFECT	Reverb	Reverb Level	p. 68
BALANCE	Key:Acmp	Balance	p. 71
	Layer	Layer Balance	p. 54
SPLIT	Split	Split Setting	p. 66
	Split Point	Split Point	p. 67
TRANSCOPE	Keybrd	Keyboard Transpose (When the Link is set to Off)	p. 61
	Keyboard/Playback	Keyboard and Playback Transpose (When the Link is set to On)	p. 38, p. 61
PEDAL	Cent	The Function Assigned to the Center Pedal	p. 69
	Left	The Function Assigned to the Left Pedal	p. 69
MIC ECHO	Type	Mic Echo Type	p. 39
	Level	Mic Echo Level	p. 39
VOCAL	Harmony	Harmony Type	p. 40
	Transformer	Transformer Type	p. 41
MIDI	Ch	MIDI Channel used for transmitting Program Change numbers when switching User Programs	p. 101
	PC	Program Change Number	p. 101
	Bank Select MSB	Bank Select MSB	p. 101
	Bank Select LSB	Bank Select LSB	p. 101

Music Files That the RG-7 Can Use

What Are Music Files?

Music files contain musical information such as how long the key for a corresponding pitch is played, the force applied to the key played, and other such information. Performance data is transmitted to the RG-7 from music files saved in USB memory and played back without change as songs. This is different than a audio CD, since the music file does not contain a recording of the sound itself. This makes it possible to erase certain parts, or to change instruments, tempos and keys freely, allowing you to use it in many different ways.

Regarding Copyright

Use of the song data supplied with the Data Disk attached to this product for any purpose other than private, personal enjoyment without the permission of the copyright holder is prohibited by law. Additionally, this data must not be copied, nor used in a secondary copyrighted work without the permission of the copyright holder.

■ The RG-7 allows you to use the following music files

SMF with Lyrics

“SMF with Lyrics” refers to SMF (Standard MIDI File) that contains the lyrics. When Music Files carrying the “SMF with Lyrics” logo are played back on a compatible device (one bearing the same logo), the lyrics will appear in its display.

The RG-7 come equipped with GM 2/GS sound generators.

■ About the RG-7 Sound Generator

The RG-8 come equipped with GM 2/GS sound generators.

General MIDI

The General MIDI is a set of recommendations which seeks to provide a way to go beyond the limitations of proprietary designs, and standardize the MIDI capabilities of sound generating devices. Sound generating devices and music files that meets the General MIDI standard bears the General MIDI logo. Music files bearing the General MIDI logo can be played back using any General MIDI sound generating unit to produce essentially the same musical performance.

General MIDI 2

The upwardly compatible General MIDI 2 recommendations pick up where the original General MIDI left off, offering enhanced expressive capabilities, and even greater compatibility. Issues that were not covered by the original General MIDI recommendations, such as how sounds are to be edited, and how effects should be handled, have now been precisely defined. Moreover, the available sounds have been expanded. General MIDI 2 compliant sound generators are capable of reliably playing back music files that carry either the General MIDI or General MIDI 2 logo.

In some cases, the conventional form of General MIDI, which does not include the new enhancements, is referred to as “General MIDI 1” as a way of distinguishing it from General MIDI 2.

GS Format

The GS Format is Roland’s set of specifications for standardizing the performance of sound generating devices. In addition to including support for everything defined by the General MIDI, the highly compatible GS Format additionally offers an expanded number of sounds, provides for the editing of sounds, and spells out many details for a wide range of extra features, including effects such as reverb and chorus. Designed with the future in mind, the GS Format can readily include new sounds and support new hardware features when they arrive. Since it is upwardly compatible with the General MIDI, Roland’s GS Format is capable of reliably playing back GM Scores equally as well as it performs GS music files (music files that have been created with the GS Format in mind). This product supports both the General MIDI 2 and the GS Format, and can be used to play back music data carrying either of these logos.

XG lite

XG is a tone generator format of YAMAHA Corporation, that defines the ways in which voices are expanded or edited and the structure and type of effects, in addition to the General MIDI 1 specification. XGlite is a simplified version of XG tone generation format. You can play back any XG music files using an XGlite tone generator. However, keep in mind that some music files may play back differently compared to the original files, due to the reduced set of control parameters and effects.

MIDI Implementation Chart

Function...	Transmitted	Recognized	Remarks	
Basic Channel Default Changed	1 1-16	1-16 1-16		
Mode Default Messages Altered	Mode 3 x *****	Mode 3 Mode 3, 4 (M=1)	* 2	
Note Number : True Voice	15-113 *****	0-127 0-127		
Velocity Note ON Note OFF	O O	O O		
After Touch Key's Ch's	x x	O O	*1 *1	
Pitch Bend	x	O		
Control Change	0, 32 1 5 6, 38 7 10 11 64 65 66 67 84 91 93 98, 99 100, 101	O x x x x x O x O O x O x x x	*1 *1 *1 *1 *1 *1 *1 *1 *1 *1 *1 *1 *1 *1 *1 *1 *1 *1	Bank select Modulation Portamento time Data entry Volume Panpot Expression Hold 1 Portamento Sostenuto Soft Portamento control Effect1 depth Effect3 depth NRPN LSB, MSB RPN LSB, MSB
Prog Change : True #	0-127 *****	O 0-127	Program number 1-128	
System Exclusive	O	O		
System Common : Song Pos : Song Sel : Tune	x x x	x x x		
System Real Time : Clock : Commands	O x	x x		
Aux Message : All sound off : Reset all controllers : Local Control : All Notes OFF : Active Sense : Reset	x x x x O x	O (120, 126, 127) O O O (123-125) O O x		
Notes	* 1 O x is selectable by SysEx. * 2 Recognized as M=1 even if M≠1.			

Mode 1 : OMNI ON, POLY

Mode 2 : OMNI ON, MONO

O : Yes

Mode 3 : OMNI OFF, POLY

Mode 4 : OMNI OFF, MONO

X : No

Main Specifications

RG-7	
<Keyboard>	
Keyboard	88 keys (Progressive Hammer Action Keyboard with Escapement)
Touch Sensitivity	Touch: 100 levels
	Hammer Response: Light, Medium, Heavy, Off
Keyboard Mode	Whole, Layer (as layer tones, volume balance adjustable), Split (split point adjustable)
Moving Key	Yes
<Sound Generator> GM2 system, GS format, XG lite compatible	
Max. Polyphony	128 voices
Tones	20 tones (5 groups 4 variations) for manual performance 600 internal tones for SMF playback
Temperament	8 types, selectable tonic
Stretched Tuning	2 types
Master Tuning	415.3 Hz–466.2 Hz (adjustable in increments of 0.1 Hz)
Transpose	Key Transpose (-6–+5 in semitones), Playback Transpose (-24–+24 in semitones)
Effects	Reverb (127 levels), Key Off Resonance (only for piano tones, 9 levels), String Resonance (only for piano tones, 9 levels), Damper Resonance (only for piano tones, 9 levels), 3-band Digital Equalizer
Vocal Effects	Mic Echo (9 levels), Harmony (7 types), Transformer (8 types)
<User Programs>	
Internal	36
User Memory	Max. 99 User Program Sets
USB Memory	Max. 99 User Program Sets
<Recorder>	
Track	1 track
Song	Max. 199 songs
Note Storage	Approx. 30,000 notes
Control	Song Select, Play/Stop, Rec, Tempo, All Song Play, Random Play, Minus One
<Media>	
CD	Read Only, Playable Disc: Audio CD (CD-DA), Data CD (SMF)
USB Memory	SMF
<Internal Memory>	
Internal Songs	Over 50 (including the Tone Demos)
User Memory	Favorites Songs, User Programs
<Others>	
Rated Power Output	60 W x 2
Speakers	16 cm x 2, 2.5 cm x 4
Display	20 characters, 2 lines LCD
External Display	VGA, NTSC, PAL Song Select, Slide Show, Lyrics, DigiScore
Control	Volume, Brilliance, LCD Contrast, Mic Volume
Pedal	Damper (half-pedal recognition), Soft (half-pedal recognition, function assignable), Sostenuto (function assignable)
Other Function	Lid Lock

Main Specifications

RG-7	
Connectors	Main Output jacks (L/Mono, R), Balanced Output jacks (L, R)(XLR, Level Fixed), Aux Output jacks (L/Mono, R), Main Input jacks (L/Mono, R), Aux Input jacks (L, R), Mic jack, Phones jack (Stereo) x 2, MIDI connector (IN/OUT), USB connector (MIDI), Ext Display jack, Video Out jack, AC Inlet, Ext Memory Port
Power Supply	AC 115 V, AC 117 V, AC 220 V, AC 230 V, AC 240 V (50/60 Hz)
Power Consumption	260 W
Dimensions	1,460 (W) x 1,400 (D) x 1,750 (H) mm (top opened) 57-1/2 (W) x 55-1/8 (D) x 68-15/16 (H) inches
	1,460 (W) x 1,400 (D) x 1,010 (H) mm (top closed) 57-1/2 (W) x 55-1/8 (D) x 39-13/16 (H) inches
Weight	225 kg / 497 lbs
Accessories	Owner's Manual, USB Installation Guide, Power Cord, CD (Music Disc with Vocals), CD-ROM (Roland Digital Piano USB Driver), Maintenance Kit, Key Cover, Remote Control, Dry-cell Batteries

* In the interest of product improvement, the specifications and/or appearance of this unit are subject to change without prior notice.

Index

- [**◀◀**] (Select +) button 14
- [**▶▶**] (Value +) button 14
- [**▶/■**] (Value -) button 14

A

- AC Inlet 15, 19
- Access Indicator 16
- Audio Equipment 97
- Automatic Demos 93
- Aux Input Jacks 15, 36
- Aux Output Jacks 15, 98

B

- Balance 71
 - Layer Balance 54
 - The Accompaniment and the Keyboard 71
- Balanced Out (Fixed) Jacks 15, 97
- Bank Select LSB 101
- Bank Select MSB 101
- Batteries 32
- [Brilliance] knob 14, 20
- Brilliance 20

C

- CD Drive 16, 29
- CD Setting
 - Level 91
 - Sync 91
 - Type 91
- CD Settings 91
- Composer MIDI Out 102
- Computer 103
- Connecting
 - Audio Equipment 97
 - Computer 103
 - External Display 47
 - External Speakers 98
 - Headphones 21
 - Microphone 21
 - MIDI Devices 99
 - Pedal Cord 19
 - Power Cord 19
 - Television 49
 - USB Memory 22
- Contrast 23
- Copying
 - Songs 42

D

- Damper Pedal 20
- Damper Resonance 20, 59
- Deleting
 - Saved User Program Sets 85
 - Songs Saved to the “Favorites” or USB Memory 45
- Disc Tray 16, 29
- Display 14
- Display Settings 48

E

- Eject Button 16, 29
- Emergency Eject Hole 16, 29
- Equalizer 60
- Ext Display Connector 15, 47
- Ext Memory Port 16, 22
- Ext Memory Port Cover 16, 22
- Ext Memory Port Cover Lock 16
- External Display 47

F

- Factory Reset 73
- Favorites 25–26, 42, 45, 76, 92
- Format
 - USB Memory 92
 - User Memory 92
- Front Panel 14
- Front Top 17
- [Function] (Exit) button 14, 88
- Function Screen 23, 88

G

- General MIDI 110
- General MIDI 2 110
- GS 110
- GS Format 110

H

- Hammer Response 56
- Harmony 34, 40
- Harmony Part 95
- Headphones 21

I

- Infrared Function 96
- Infrared Playback 96
- Infrared Receiver 16, 33
- Initialize 92
- Input Jacks 15, 97
- Internal Songs 26

- J**
 Jack Panel 15
- K**
 Karaoke Feature 37
 Key Off Resonance 57
 Key Touch 55
- L**
 Layer Balance 54
 Layer Tones 54
 LCD Contrast knob 15, 23
 Lid 18
 Lid Lock 18
 Loading
 Saved User Program Sets 83
 Local Control 101
 Local Off 101
 Local On 101
 Lyrics 50
 Lyrics Screen 52
- M**
 Main Output Jacks 15, 97
 Master Tuning 62
 Memory Backup 72
 Parameters Stored 109
 Mic Echo 39
 Mic Jack 15, 21
 Mic Volume Knob 15, 21
 Microphone 21
 MIDI 99
 MIDI Connectors 15, 99
 MIDI Devices 99
 MIDI In Connector 99
 MIDI Out Connector 99
 MIDI Transmit Channel 100
 Minus One 93
 Moving Key 88–89
 [Moving Key] (Enter) button 14, 88
 Music Files 110
 Music Rest 18
 Mute 35
 Specifying the Part 94
- N**
 Notation 50, 94
 Notation Settings 94
- O**
 Output Jacks 97
- P**
 Pedal 20
 Pedal Connector 15, 19
 Pedal Cord 19
 Pedal EX 70
 Pedal Settings 69
 Phones Jacks 15, 21
 Playback Transpose 38
 Playing
 All Song 27
 Internal Songs 26
 One Song 27
 Random 35
 Recorded Performance 75
 Songs on CDs 28
 Songs Saved on USB Memory 31
 Tone Demos 26
 Power Cord 19
 Power On and Off 19
 [Power] switch 14, 19
 Program Change 101
- R**
 Recording 74
 Remote Control 32–35, 37, 50, 89–90
 Reverb 68
- S**
 Saving
 Performance Settings (User Program) 79
 Recorded Performances 76
 User Program Sets 81
 Screens
 AUX INPUT screen 36
 AUX OUTPUT screen 98
 BALANCE screen 54, 71
 CD screen 91
 EFFECT screen 68
 EQUALIZER screen 60
 EXT DISPLAY screen 48–49, 51
 FACTORY RESET screen 73
 FILE screen 42, 45, 76, 92
 Function Screen 23
 iR screen 96
 KEY TOUCH screen 55–56
 MEMORY BACKUP screen 72

Index

MIC ECHO screen 39
MIDI screen 92, 100–103
MISC Harmony Part screen 95
MISC Moving Key Part screen 89
NOTATION screen 94
PEDAL screen 69
PLAY screen 27, 93
RECORD screen 74
REMOTE screen 89–90, 96
RESONANCE screen 57–59
Song Select screen 23
SPLIT screen 66–67
Tone Screen 53
TRANSCOPE screen 38, 61
TUNE screen 62–65
USER PROGRAM screen 79, 81, 83, 85, 87
VOCAL screen 40–41
Slide Show 50–51
SMF with Lyrics 110
Soft Pedal 20, 69
[Song] (Select -) button 14, 25
Song Select Screen 23, 50
Sostenuto Pedal 20, 69
Sound Generator 110
Split 66
Split Point 67
Stretch Tuning 63
String Resonance 58

T

Television 49
Television Format 49
Temperament 64
Tempo 37
Tone 53
Tone Buttons 14, 53
Tone Demos 26
Tone Group 53
Tone Screen 23
Tonic 65
Topslip 17
Topsticks 17
Transformer 34, 41
Transpose 38, 61
Tuning 64
Tuning Curve 63

U

USB Connector 15, 103
USB Driver 103
USB Memory
.....22, 31, 37, 42, 45, 51–52, 76, 81, 83, 85, 92–93
User Memory 25, 81, 83, 85, 92
User Program 78
 Calling Up 80
 Deleting 85
 Loading 83
 Parameters Stored 109
 Pedal Shift 87
 Saving 79, 81
 Transmit Channel 102

V

Variation 53
Video Out Jack 15, 49
V-LINK Function 92
Volume
 CD 35
 Microphone 21
 Overall 20
[Volume] knob 14, 20

X

XG lite 110

MEMO

MEMO

For EU Countries



This product complies with the requirements of European Directives EMC 89/336/EEC and LVD 73/23/EEC.

For the USA

FEDERAL COMMUNICATIONS COMMISSION RADIO FREQUENCY INTERFERENCE STATEMENT

This equipment has been tested and found to comply with the limits for a Class B digital device, pursuant to Part 15 of the FCC Rules. These limits are designed to provide reasonable protection against harmful interference in a residential installation. This equipment generates, uses, and can radiate radio frequency energy and, if not installed and used in accordance with the instructions, may cause harmful interference to radio communications. However, there is no guarantee that interference will not occur in a particular installation. If this equipment does cause harmful interference to radio or television reception, which can be determined by turning the equipment off and on, the user is encouraged to try to correct the interference by one or more of the following measures:

- Reorient or relocate the receiving antenna.
- Increase the separation between the equipment and receiver.
- Connect the equipment into an outlet on a circuit different from that to which the receiver is connected.
- Consult the dealer or an experienced radio/TV technician for help.

This device complies with Part 15 of the FCC Rules. Operation is subject to the following two conditions:

- (1) This device may not cause harmful interference, and
- (2) This device must accept any interference received, including interference that may cause undesired operation.

Unauthorized changes or modification to this system can void the users authority to operate this equipment.
This equipment requires shielded interface cables in order to meet FCC class B Limit.

For Canada

NOTICE

This Class B digital apparatus meets all requirements of the Canadian Interference-Causing Equipment Regulations.

AVIS

Cet appareil numérique de la classe B respecte toutes les exigences du Règlement sur le matériel brouilleur du Canada.

For the USA

DECLARATION OF CONFORMITY Compliance Information Statement

Model Name : RG-7
Type of Equipment : Digital Piano
Responsible Party : Roland Corporation U.S.
Address : 5100 S. Eastern Avenue Los Angeles, CA 90040-2938, U. S. A.
Telephone : (323) 890 3700

